

**GEA COLLECTIONS /
LOFT 2.2 PET /
LOFT 2.2 SUPERMATT NEW /
CSA - COLOR SELECTIONS ARREX**

#1 Lookbook

ARREX
LE - CUCINE

ARREX
L E _ C U C I N E

Etica ed estetica

^{EN} Ethics and aesthetics
^{FR} Éthique et esthétique
^{ES} Ética y estética

**GEA COLLECTIONS /
LOFT 2.2 PET /
LOFT 2.2 SUPERMATT NEW /
CSA - COLOR SELECTIONS ARREX**



Siamo sostenibili per attitudine,

è il nostro modo di guardare il mondo. Sostenibilità per noi significa attenzione all'ambiente e alle persone a cui dedichiamo i nostri progetti. L'anima ecologica dei nostri sistemi, il design equilibrato e la flessibilità delle composizioni raccontano la nostra visione etica dell'abitare e il nostro impegno per la qualità dell'esistenza.



EN We are sustainable by aptitude, it is our way of looking at the world. Sustainability for us means attention to the environment and the people to whom we devote our projects. The ecological soul of our systems, the balanced design and the flexibility of the compositions tell the story of our ethical vision of living and our commitment to the quality of life.
FR Nous sommes durables par aptitude, c'est notre façon de regarder le monde. Pour nous, durabilité signifie attention à l'environnement et aux personnes à qui nous dédions nos projets. L'âme écologique de nos systèmes, la conception équilibrée et la flexibilité des compositions racontent l'histoire de notre vision éthique de l'habiter et notre engagement pour la qualité de la vie.

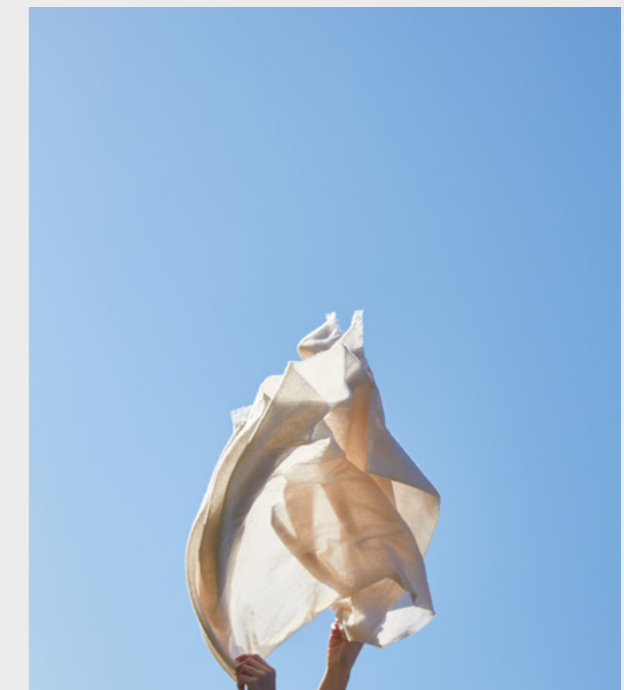

ES Somos sostenibles por aptitud, es nuestra forma de mirar el mundo. Sostenibilidad para nosotros significa atención al medio ambiente y las personas a las que dedicamos nuestros proyectos. El alma ecológica de nuestros sistemas, el diseño equilibrado y la flexibilidad de las composiciones cuentan la historia de nuestra visión ética del habitar y nuestro compromiso para la calidad de la vida.

Leggerezza, fluidità, circolarità, evoluzione

sono qualità preziose della natura.
Per noi sono principio e ispirazione.
Appartengono al mondo Arrex,
guidano la nostra ricerca e il nostro
percorso di sostenibilità.

^{EN} Lightness, fluidity, circularity, evolution
are precious qualities of nature. For
us, they are principle and inspiration.
They belong to the Arrex world, they
guide our research and our route to
sustainability. ^{FR} Légèreté, fluidité,
circlarité, évolution sont qualités
précieuses de la nature. Pour nous, ils
sont principe et source d'inspiration.
Ils appartiennent au monde Arrex,
ils guident notre recherche et notre
parcours de durabilité. ^{ES} Ligereza,
fluidez, circularidad, evolución son
cualidades preciosas de la naturaleza.
Para nosotros, son principio e
inspiración. Pertenecen al mundo Arrex,
guían nuestra investigación y nuestro
recorrido hacia la sostenibilidad.



01

Evoluzione come crescita responsabile verso l'ambiente e le persone.

^{EN} Evolution as growth responsible towards
the environment and people.
^{FR} Évolution comme croissance responsable
envers l'environnement et les personnes.
^{ES} Evolución como crecimiento responsable
hacia el medio ambiente y las personas.



Leggerezza come strategia di impatto minimo sull'ambiente.

^{EN} Lightness as a strategy with minimal
impact on the environment. ^{FR} Légèreté
comme stratégie avec un impact minimal
sur l'environnement. ^{ES} Ligereza como
estrategia con el mínimo impacto en el
medio ambiente.



02



⁰¹ Terra / Earth / Terre / Tierra
⁰² Aria / Air / Air / Aire
⁰³ Fuoco / Fire / Feu / Fuego
⁰⁴ Acqua / Water / Eau / Agua



Fluidità come
razionalità
dei processi
produttivi.

*EN Fluidity as rationality
of production processes.
FR Fluidité comme
rationalité des processus
de production.
ES Fluidez como
racionalidad de los
procesos productivos.*



Circularità
come uso
consapevole
delle risorse
e scelta di
materiali
riciclabili.

*EN Circularity as a
conscious use of
resources and choice of
recyclable materials.
FR Circularité comme
utilisation consciente des
ressources et choix de
matériaux recyclables.
ES Circularidad como
uso consciente de los
recursos y elección de
materiales reciclables.*

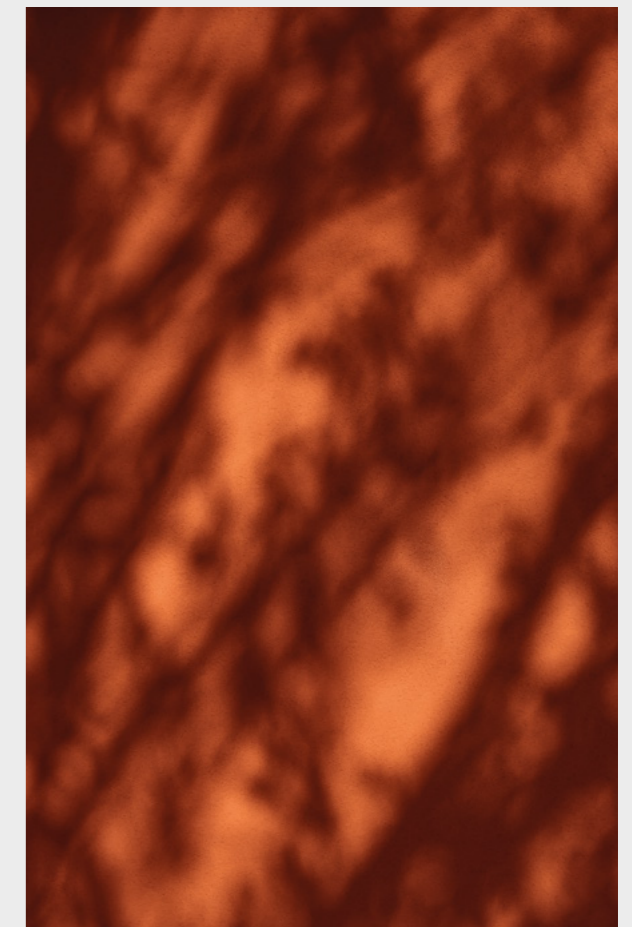
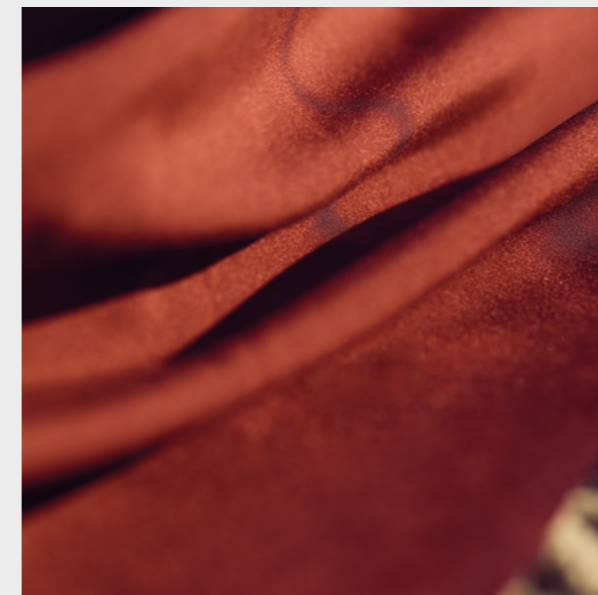

Pensare sostenibile per noi significa anche alimentare la connessione sensoriale ed emotiva tra l'uomo e il suo ambiente

ispirando il senso della natura. Lavoriamo con passione perché i sistemi cucina che immaginiamo non siano solo funzionali e sicuri. Ci piace l'idea che siano vissuti in modo naturale, sereno e conviviale. Dedichiamo la nostra ricerca agli infiniti modi dell'abitare e alla meravigliosa sensazione di stare bene nell'ambiente che abitiamo.



EN For us, sustainable thinking also means feeding the sensory and emotional connection between man and his environment, inspiring a sense of nature. We work with passion to ensure that the kitchen systems we imagine are not only functional and safe. We like the idea that they are lived in a natural, serene and convivial way. We devote our research to the innumerable ways of living and to the wonderful sense of feeling good in the environment we inhabit.

FR Pour nous, penser durablement signifie également alimenter la connexion sensorielle et émotionnelle entre l'homme et son environnement, en inspirant un sens de la nature. Nous travaillons avec passion pour que les systèmes cuisine que nous imaginons ne soient pas seulement fonctionnels et sûrs. Nous aimons l'idée qu'ils soient vécus de manière naturelle, sereine et conviviale. Nous consacrons notre recherche aux modes infinis de l'habiter et à la merveilleuse sensation de se sentir bien dans l'environnement que nous habitons.

ES Para nosotros, pensar sostenible también significa alimentar la conexión sensorial y emotiva entre el hombre y su entorno, inspirando un sentido de la naturaleza. Trabajamos con pasión para que los sistemas cocina que imaginamos no solo sean funcionales y seguros. Nos gusta la idea de que se vivan de forma natural, serena y agradable. Dedicamos nuestra investigación a las infinitas formas del habitar y a la maravillosa sensación de sentirse bien en el entorno que habitamos.



Dalla ricerca ARREX oggi nasce l'anta GEA,

una bellissima espressione del nostro pensiero green e della nostra ricerca stilistica, immaginata in 5 finiture eco PET, 3 cementi PET 100% riciclabili e una inedita selezione di colori laccati raccolti in 4 mood Aria, Acqua, Terra e Fuoco. Ogni elemento evoca una magia, una sensazione, una qualità dell'abitare che sentiamo appartenere al nostro mondo e alla nostra espressività.



EN Today, from ARREX research comes into being the door GEA, a beautiful expression of our green thinking and our stylistic research, imagined in 5 eco PET finishes, 3 100% recyclable PET cements and a new selection of lacquered colors collected in 4 moods Air, Water, Earth and Fire. Each element evokes a magic, a sensation, a quality of living that we feel belong to our world and our expressiveness.

FR Aujourd'hui, de la recherche ARREX naît la porte GEA, une belle expression de notre pensée green et de notre recherche stylistique, imaginée en 5 finitions PET éco, 3 ciments PET 100% recyclables et une sélection inédite de couleurs laquées rassemblées dans 4 ambiances Air, Eau, Terre et Feu. Chaque élément évoque une magie, une sensation, une qualité de l'habiter que nous sentons appartenir à notre monde et à notre expressivité.

ES Hoy, de la investigación ARREX nace la puerta GEA, una hermosa expresión de nuestro pensamiento green y de nuestra investigación estilística, imaginada en 5 acabados eco PET, 3 cementos PET 100% reciclables y una selección inédita de colores lacados recogidos en 4 ambientes Aire, Agua, Tierra y Fuego. Cada elemento evoca una magia, una sensación, una calidad del habitar que sentimos pertenecer a nuestro mundo y a nuestra expresividad.

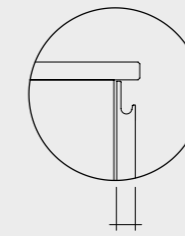
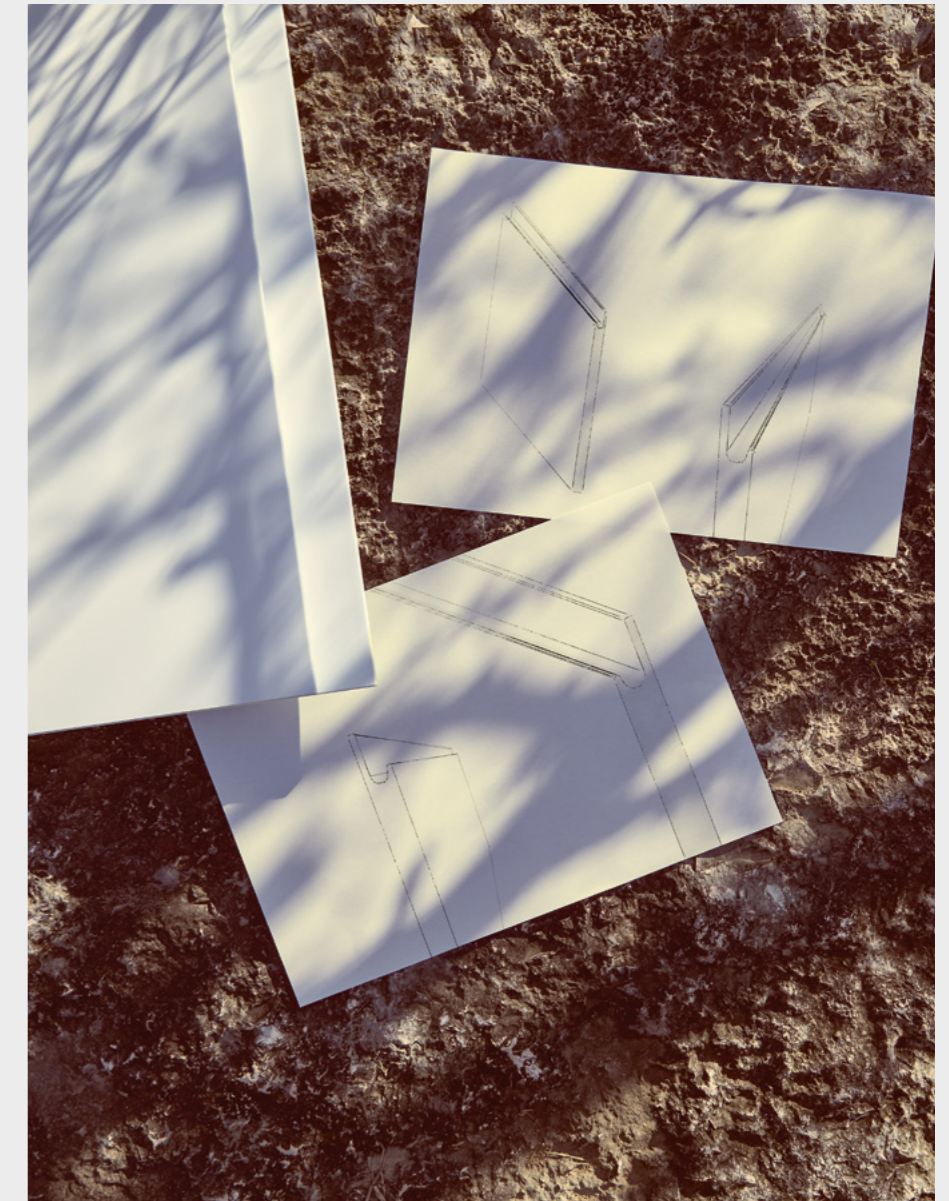

sp. 22 mm

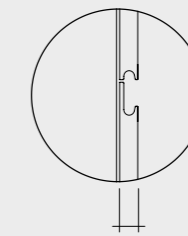

sp. 22 mm

Essenzialità minerale. La nuova estetica del PET.

Le nuove finiture PET cemento e Eco PET liscio vestono le ante GEA e LOFT 2.2. I colori si ispirano al mondo minerale, a superfici naturali solide e materiche, oppure brillanti e cristalline come zucchero.

PET Cemento

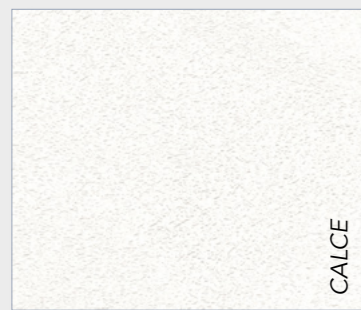

CALCE

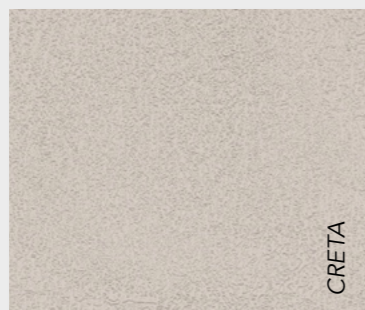

CRETA

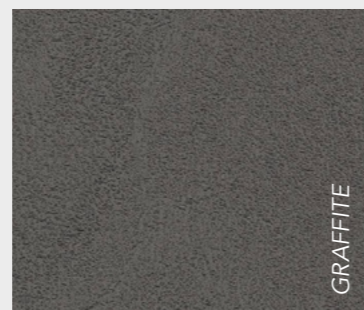

GRAFFITE

ECO PET Liscio

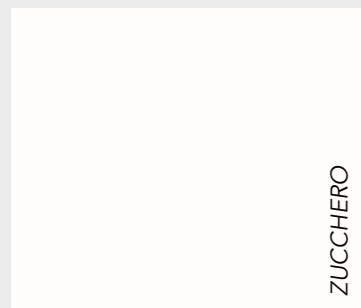

ZUCCHERO

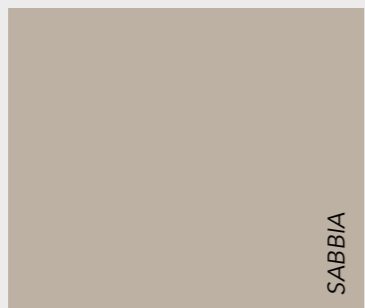

SABBIA



SASSO

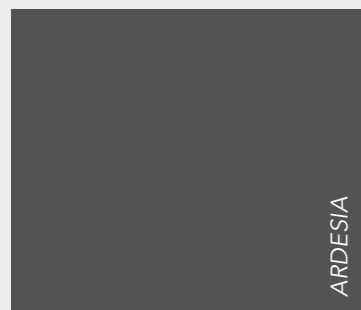

ARDESIA

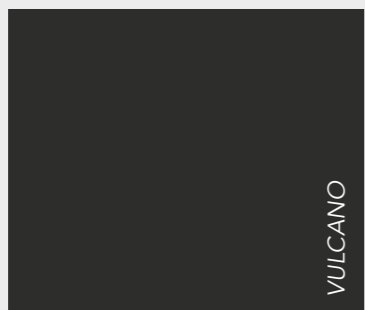

VULCANO

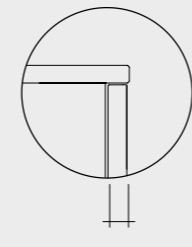

sp. 22 mm

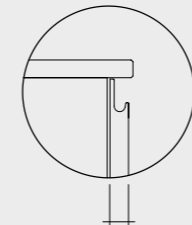

sp. 22 mm

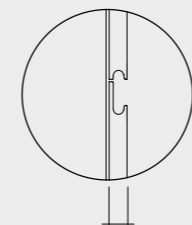

sp. 22 mm

EN Mineral essentiality.
 The new aesthetics of PET.
 The new PET cement and smooth Eco PET finishes dress the GEA and LOFT 2.2 doors. Colours are inspired by the mineral world, by solid and material or bright and crystalline like sugar natural surfaces. **FR** Essentialité minérale.
 La nouvelle esthétique du PET.
 Les nouvelles finitions PET ciment et Eco PET lisse habillent les portes GEA et LOFT 2.2. Les couleurs s'inspirent du monde minéral, des surfaces naturelles solides et matérielles, ou brillantes et cristallines comme le sucre. **ES** Esencialidad mineral.
 La nueva estética del PET.
 Los nuevos acabados PET cemento y Eco PET liso visten las puertas GEA y LOFT 2.2. Los colores se inspiran en el mundo mineral, en superficies naturales sólidas y materiales, o brillantes y cristalinas como el azúcar.



CSA Color Selection ARREX

CSA è un progetto colore nato dall'incontro di tre mondi: il senso della natura che ispira la nostra ricerca, la visione sostenibile che appartiene all'anima di ARREX, il valore simbolico ed emozionale dei colori. Dalla relazione natura-sostenibilità-colore hanno preso vita quattro mood: Acqua, Aria, Terra, Fuoco. Quattro gruppi cromatici tra loro uniti e compatibili, dedicati al piacere di stare bene e di sentirsi in sintonia con ciò che abbiamo intorno.

^{EN} CSA is a color project born from the meeting of three worlds: the sense of nature that inspires our research, the sustainable vision that belongs to the soul of ARREX, the symbolic and emotional value of colors. Four moods have come to life from the relationship nature-sustainability-color: Water, Air, Earth, Fire. Four chromatic groups united and compatible, dedicated to the pleasure of feeling good and tuned in to what surrounds us. ^{FR} CSA est un projet couleur né de la rencontre de trois mondes : le sens de la nature qui inspire nos recherches, la vision durable qui appartient à l'âme d'ARREX, la valeur symbolique et émotionnelle des couleurs. Quatre ambiances ont vu le jour à partir de la relation entre nature-durabilité-couleur : Eau, Air, Terre, Feu. Quatre groupes chromatiques unis et compatibles, dédiés au plaisir de se sentir bien et d'être sur la même longueur d'ondes avec ce qui nous entoure.

^{ES} CSA es un proyecto color nacido del encuentro de tres mundos: el sentido de la naturaleza que inspira nuestra investigación, la visión sostenible que pertenece al alma de ARREX, el valor simbólico y emocional de los colores. De la relación naturaleza-sostenibilidad-color han surgido cuatro ambientes: Agua, Aire, Tierra, Fuego. Cuatro grupos cromáticos unidos y compatibles, dedicados al placer de sentirnos bien y en sintonía con lo que nos rodea.



Moodboard Aria_Leggerezza

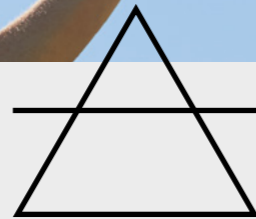

^{EN} Air_Lightness
^{FR} Air_Légèreté
^{ES} Aire_Ligereza

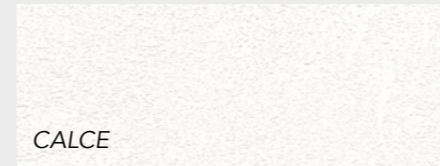

CALCE

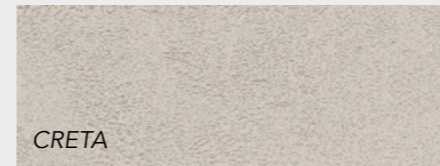

CRETA

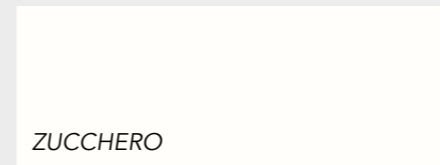

ZUCCHERO



SASSO

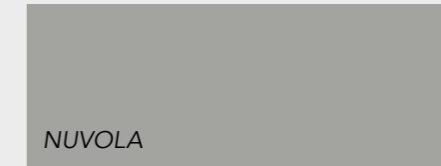

NUVOLA



POLVERE

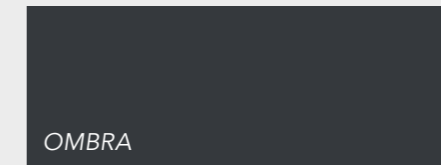

OMBRA



NCS S 0603-R80B



NCS S 3502 - G



NCS S 2010-B10G

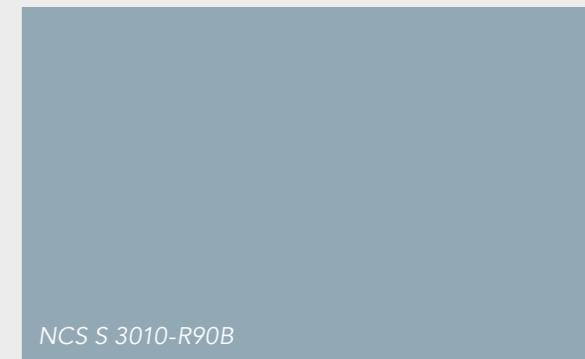

NCS S 3010-R90B

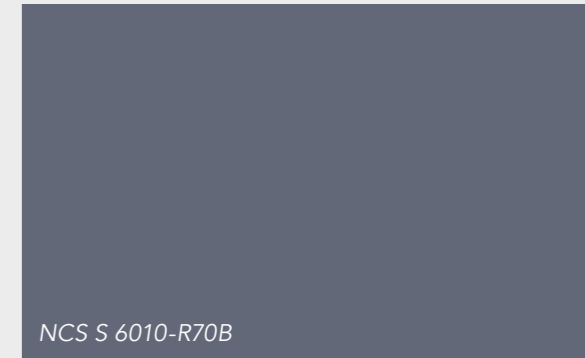

NCS S 6010-R70B

È il senso della levità. Ispira l'idea di impatto delicato, rispettoso verso le persone e l'ambiente. Evoca trasparenze e colori tenui, eterei e polverosi, le sfumature del cielo, fresche e senza il senso della gravità.

^{EN} It is the sense of levity. It inspires the idea of a gentle, respectful impact on people and the environment. It evokes transparencies and soft colors, ethereal and dusty, the shades of the sky, fresh and without the sense of gravity. ^{FR} C'est le sentiment de légèreté. Il inspire l'idée d'un impact délicat, respectueux envers les personnes et l'environnement. Il évoque transparences et couleurs douces, éthérées et poussiéreuses, les nuances du ciel, fraîches et sans le sens de la gravité. ^{ES} Es la sensación de la levedad. Inspira la idea de un impacto suave, respetuoso hacia las personas y el medio ambiente. Evoca transparencias y colores claros, etéreos y polvorientos, los matices del cielo, frescos y sin el sentido de la gravedad.

Moodboard Acqua_Fluidità

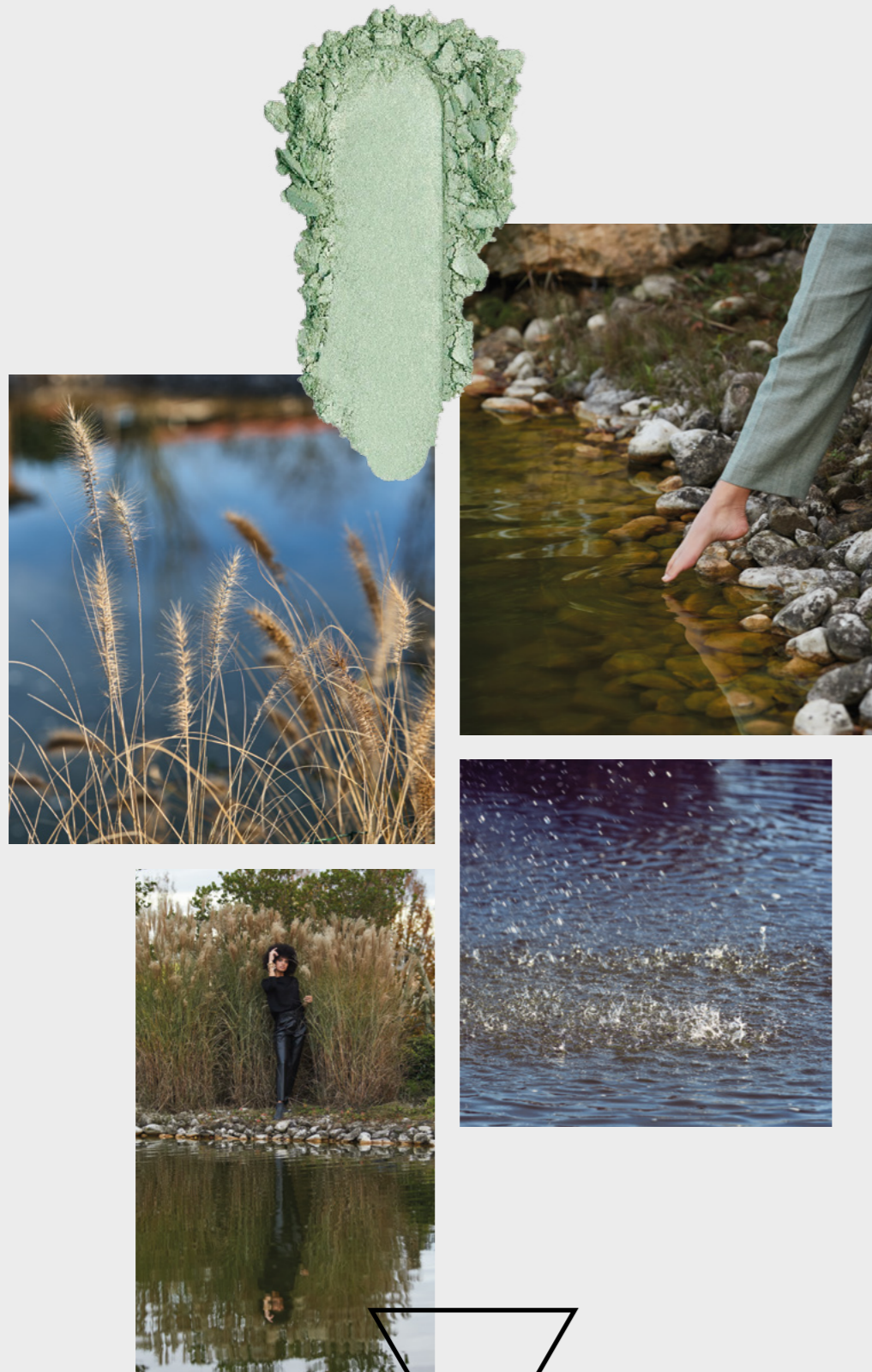

^{EN} Water_Fluidity.
^{FR} Eau_Fluidité
^{ES} Agua_Fluidéz

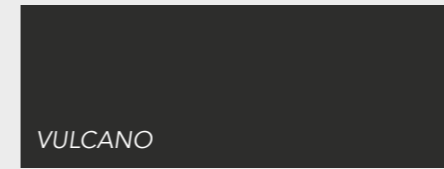
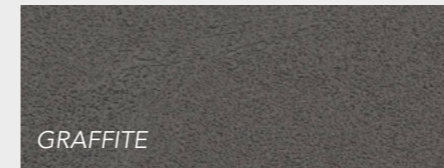
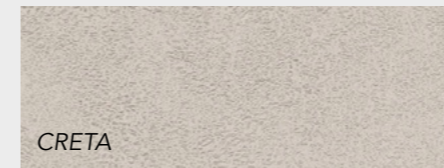

È l'elemento della libertà. Fluidità di movimento nello spazio, fluidità di relazione tra l'uomo e l'ambiente. Lascia immaginare forme libere e colori freschi e brillanti, sfumature di verde in cui ritrovare la sensazione del mare.

^{EN} It is the element of freedom. Fluidity of movement in space, fluidity of relationship between man and the environment. It lets imagine free shapes and fresh, bright colors, shades of green in which rediscover the sensation of the sea. ^{FR} C'est l'élément de la liberté. Fluidité du mouvement dans l'espace, fluidité de relation entre l'homme et l'environnement. Il laisse imaginer formes libres et couleurs fraîches et vives, nuances de vert dans lesquelles retrouver la sensation de la mer. ^{ES} Es el elemento de la libertad. Fluidez de movimiento en el espacio, fluidez de relación entre el hombre y el medio ambiente. Deja imaginar formas libres y colores frescos y brillantes, tonos verdes en los que redescubrir la sensación del mar.



Moodboard Terra_Evoluzione

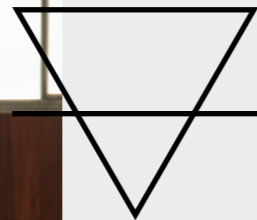
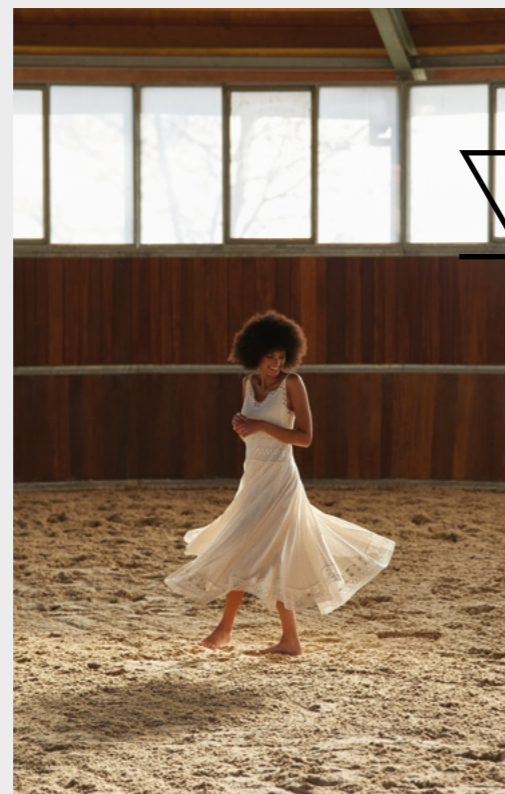

^{EN} Earth_Evolution
^{FR} Terre_Évolution
^{ES} Tierra_Evolución

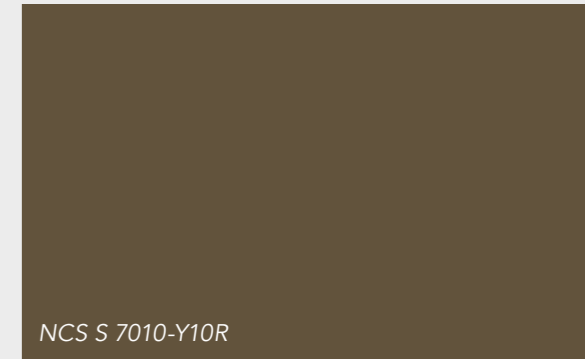
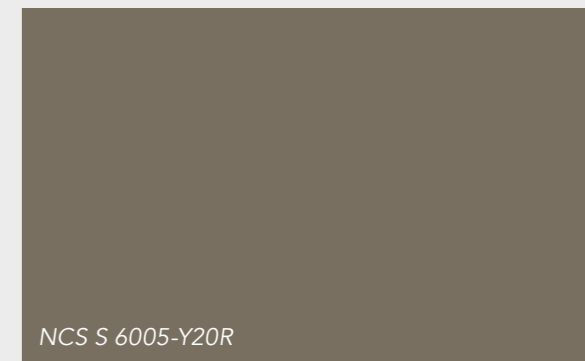
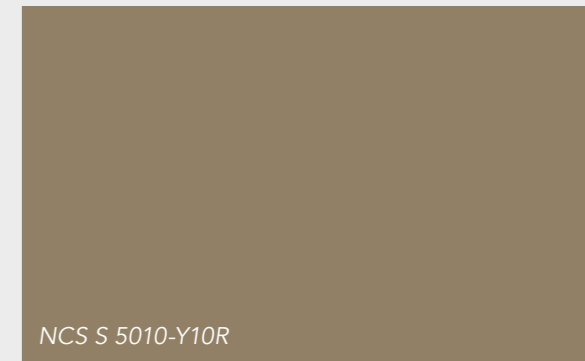
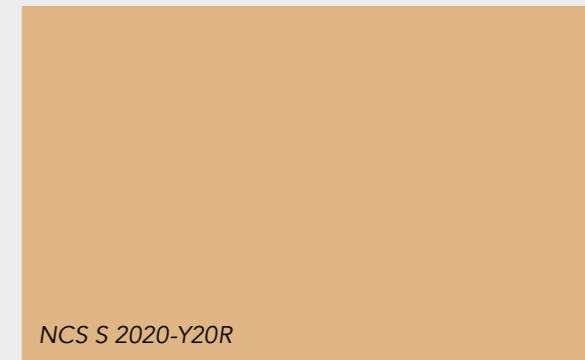
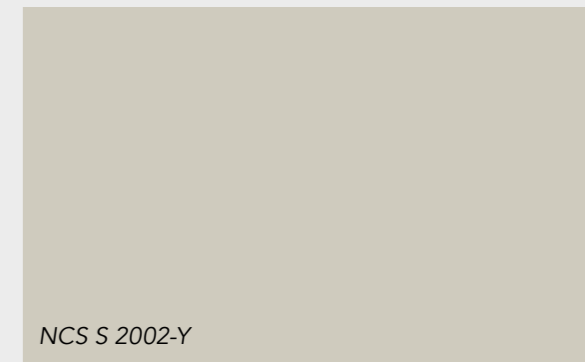
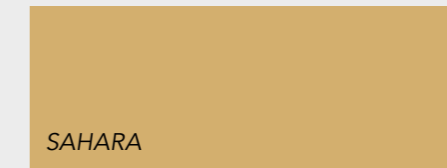
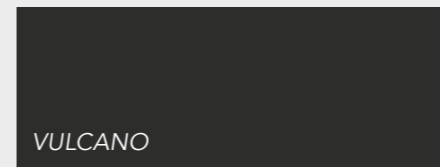
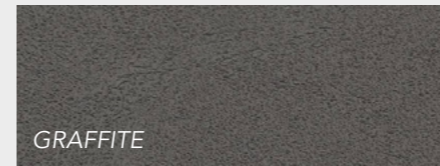
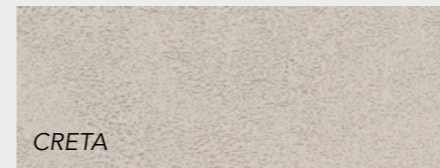

Simbolo di crescita e trasformazione. Evoca l'idea di una creatività libera e flessibile, eppure fondata sulla solidità degli elementi e sulla razionalità. Abbraccia le sfumature neutre e i colori dorati della pietra e della sabbia.

^{EN} Symbol of growth and transformation. It evokes the idea of a free and flexible creativity, yet based on the solidity of the elements and rationality. It embraces the neutral hues and golden colors of stone and sand. ^{FR} Symbole de croissance et de transformation. Il évoque l'idée d'une créativité libre et flexible, mais basée sur la solidité des éléments et la rationalité. Il embrasse les nuances neutres et les couleurs dorées de la pierre et du sable. ^{ES} Símbolo de crecimiento y transformación. Evoca la idea de una creatividad libre y flexible, pero basada en la solidez de los elementos y la racionalidad. Abraza los tonos neutros y los colores dorados de la piedra y la arena.

Moodboard Fuoco_Circolarità

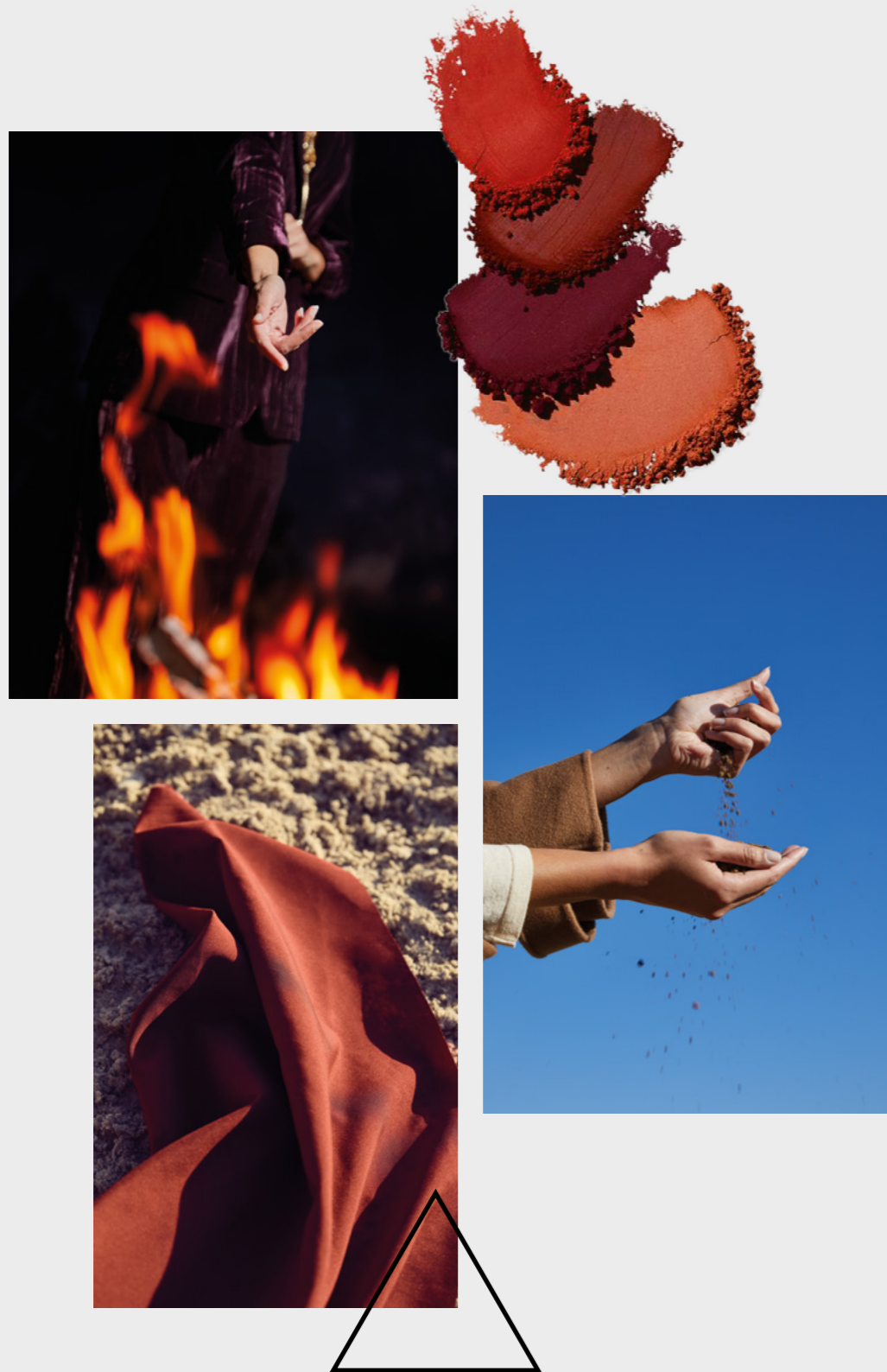

^{EN} Fire_Circularity
^{FR} Feu_Circularité
^{ES} Fuego_Circularidad

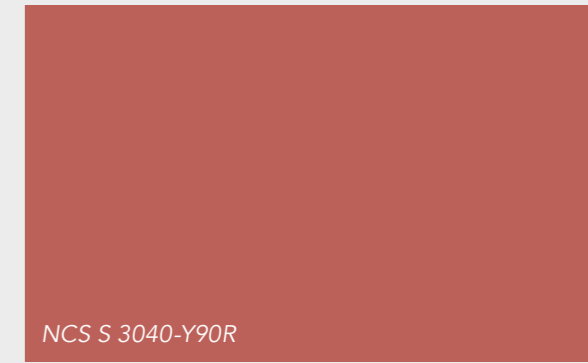
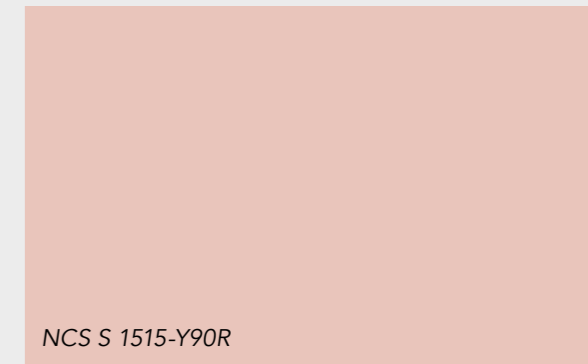
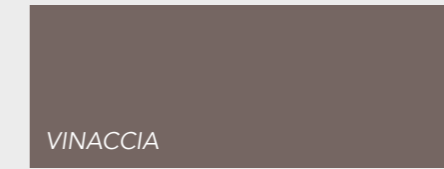
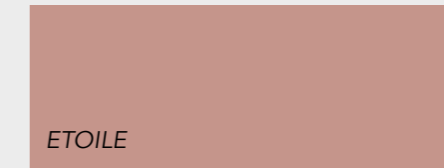
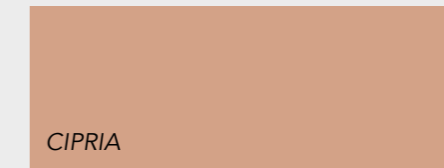
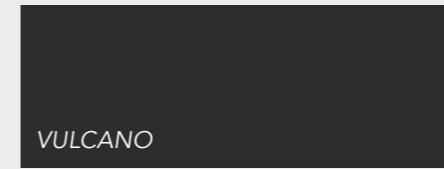
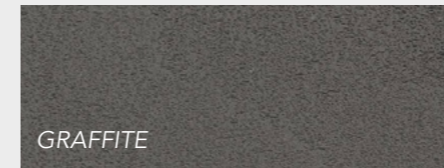
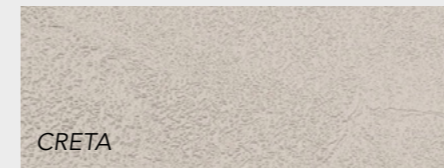

Richiama l'idea del focolare. È energia e libertà. Evoca un modello di produzione orientato al risparmio di risorse e all'uso di materiali riciclabili e green. Ispira ambienti dai toni caldi e avvolgenti, le nuance del sole dedicate al piacere di condividere.

^{EN} It calls to mind the idea of the hearth and home. It is energy and freedom. It evokes a production model oriented to saving resources and the use of recyclable and green materials. It inspires environments with warm and enveloping tones, the nuances of the sun dedicated to the pleasure of sharing. ^{FR} Il rappelle l'idée du foyer domestique. C'est énergie et liberté. Il évoque un modèle de production orienté à l'économie des ressources et à l'utilisation de matériaux recyclables et green. Il inspire des environnements aux tons chauds et enveloppants, les nuances du soleil dédiées au plaisir du partager. ^{ES} Recuerda la idea del hogar doméstico. Es energía y libertad. Evoca un modelo productivo orientado al ahorro de recursos y al uso de materiales reciclables y green. Inspira ambientes con tonos cálidos y envolventes, los matices del sol dedicados al placer de compartir.

Finiture e colori. La natura ispira sempre.

^{EN} Finishes and colours. Nature always inspires.
^{FR} Finitions et couleurs. La nature toujours inspire.
^{ES} Acabados y colores. La naturaleza siempre inspira.

LOFT 2.2 / GEA **Pet**

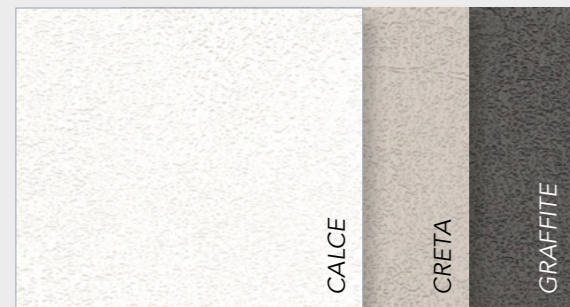

PET Cemento
^{EN} PET Cement ^{FR} PET Ciment
^{ES} PET Cemento

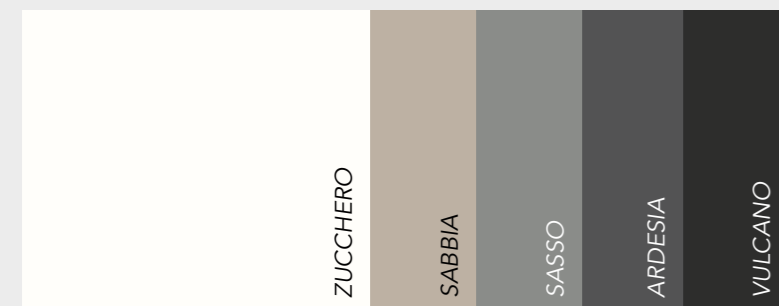

ECO PET Liscio
^{EN} ECO PET Smooth ^{FR} ECO PET Lisse
^{ES} ECO PET Liso



LOFT 2.2 **Supermatt**

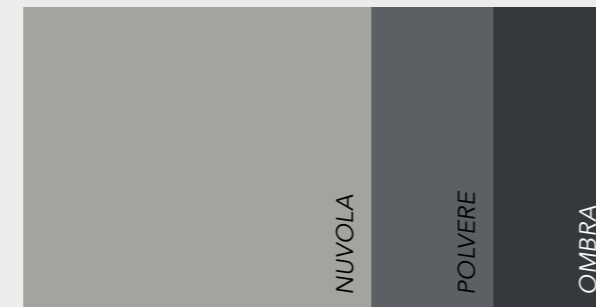

LAMINATI ARIA
^{EN} LAMINATES AIR ^{FR} STRATIFIÉS AIR
^{ES} LAMINADOS AIRE



LAMINATI ACQUA
^{EN} LAMINATES WATER ^{FR} STRATIFIÉS EAU
^{ES} LAMINADOS AGUA



LAMINATI TERRA
^{EN} LAMINATES EARTH ^{FR} STRATIFIÉS TERRE
^{ES} LAMINADOS TIERRA

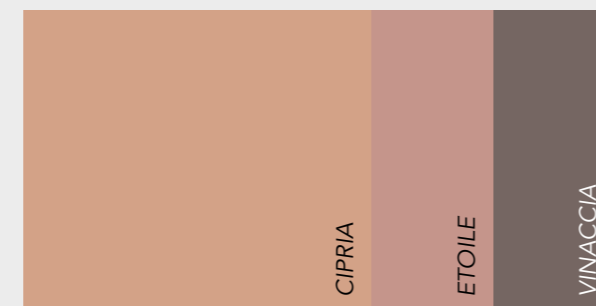

LAMINATI FUOCO
^{EN} LAMINATES FIRE ^{FR} STRATIFIÉS FEU
^{ES} LAMINADOS FUEGO



LOFT 2.2 / GEA **Line**



LACCATI ARIA Lucido / Opaco
^{EN} LACQUERED AIR Polished / Matt ^{FR} LAQUÉS AIR Poli / Mat ^{ES} LACADOS AIRE Pulido / Mate

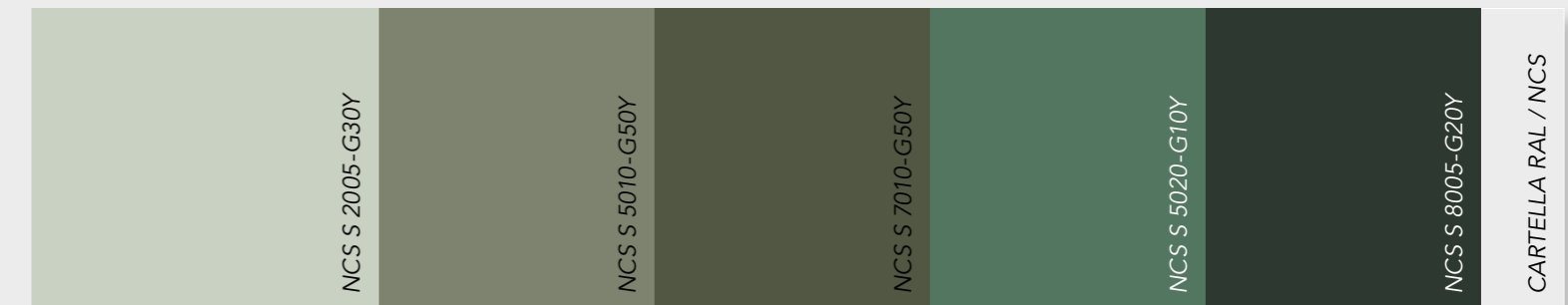

LACCATI ACQUA Lucido / Opaco
^{EN} LACQUERED WATER Polished / Matt ^{FR} LAQUÉS EAU Poli / Mat ^{ES} LACADOS AGUA Pulido / Mate

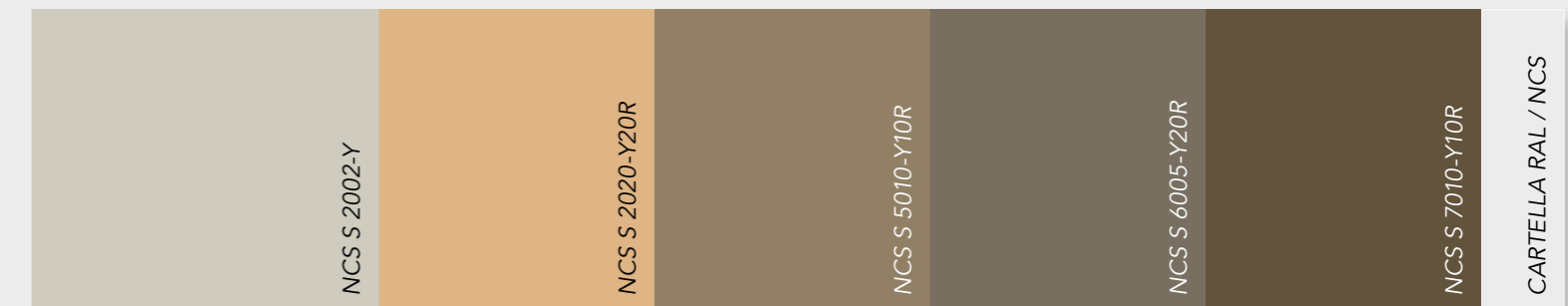

LACCATI TERRA Lucido / Opaco
^{EN} LACQUERED EARTH Polished / Matt ^{FR} LAQUÉS TERRE Poli / Mat ^{ES} LACADOS TIERRA Pulido / Mate

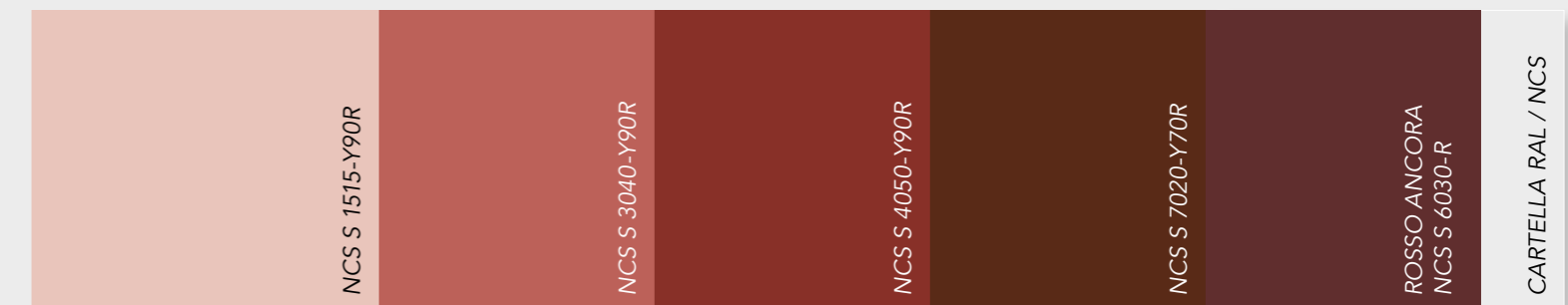

LACCATI FUOCO Lucido / Opaco
^{EN} LACQUERED FIRE Polished / Matt ^{FR} LAQUÉS FEU Poli / Mat ^{ES} LACADOS FUEGO Pulido / Mate



ARREX
L E _ C U C I N E

Nella bellezza dello spazio
cresce la qualità del tempo.

^{EN} *In the beauty of space, the quality of time grows.*
^{FR} *Dans la beauté de l'espace, la qualité du temps grandit.*
^{ES} *En la belleza del espacio, crece la calidad del tiempo.*

Il mondo Gea. Il nostro modo di pensare sostenibile.

^{EN} The Gea world. Our way of sustainable thinking. ^{FR} Le monde Gea. Notre façon de penser durablement. ^{ES} El mundo Gea. Nuestra forma de pensar sostenible .



01 TERRA
EARTH / TERRE / TIERRA

pag.
033



03 ARIA
AIR / AIR / AIRE

pag.
057



05 FUOCO
FIRE / FEU / FUEGO

pag.
081



07 ACQUA
WATER / EAU / AGUA

pag.
105



02 ACQUA
WATER / EAU / AGUA

pag.
045



04 TERRA
EARTH / TERRE / TIERRA

pag.
069



06 ARIA
AIR / AIR / AIRE

pag.
093



08 FUOCO
FIRE / FEU / FUEGO

pag.
117

01
Rigore ed
essenzialità
tono su
tono.

*EN Rigour and essentiality tone on tone.
FR Rigueur et essentialité ton sur ton.
ES Rigor y esencialidad tono sobre tono.*







Basi e Colonne

Zoccolo h.8 cm
metallo laccato
NCS S 3005-Y50R

Accessori interni

Colonna da 75 h.210 cm
con anta scorrevole
rientrante Tipo_D

EN Bases and Columns with kick plate 8 cm. h. lacquered metal NCS S 3005-Y50R. *FR* Bases et Colonnes avec Plinthe 8 cm h. métal laqué NCS S 3005-Y50R. *ES* Bases y Columnas con Zócalo h. 8 cm metal lacado NCS S 3005-Y50R.

EN Internal accessories Column 75 210 h. cm. with re-entrant sliding door Type_D. *FR* Accessoires intérieurs Colonne de 75 210 cm h. avec porte à glissière rentrante Type_D. *ES* Accesorios interiores Columna de 75 h. 210 cm con puerta corredera entrante Tipo_D.



Vasca costruita
74 x 44 cm
Gres Shilin

^{EN} Assembled tank 74 x 44 cm. Gres Shilin. ^{FR} Bac assemblé 74 x 44 cm Gres Shilin. ^{ES} Decantador ensamblado 74 x 44 cm Gres Shilin.

Accessori
Cassetti e cestoni Blum Legrabox grigio orione

Portaposate in plastica Essetre Whitty-Line con accessori interni

^{EN} Accessories Drawers and deep drawers Blum Legabrox grey orion. Plastic cutlery tray Essetre Whitty-Line with internal accessories. ^{FR} Accessoires tiroirs et grands tiroirs Blum Legrabox gris orion. Étui à couverts en plastique Essetre Whitty-Line avec accessoires intérieurs. ^{ES} Accesorios Cajones y cajones grandes Blum Legrabox gris orión. Cubertero de plástico Essetre Whitty-Line con accesorios interiores.

La solidità monolitica dei volumi e la continuità delle superfici infondono un senso di ordine e di purezza formale.

^{EN} The monolithic solidity of volumes and the continuity of surfaces inspire a sense of order and formal purity.
^{FR} La solidité monolithique des volumes et la continuité des surfaces insufflent un sentiment d'ordre et de pureté formelle.
^{ES} La solidez monolítica de los volúmenes y la continuidad de las superficies infunden una sensación de orden y pureza formal.



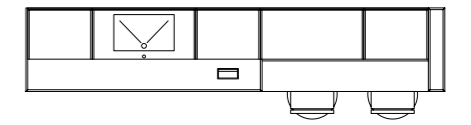
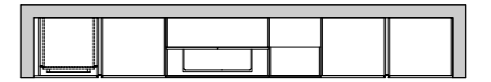

Piano lavoro
Gres Shilin sp.1,2 cm con vasca costruita

Modulo Prese
A scomparsa nero opaco

EN Countertop in Gres Shilin 1,2 cm. th. with assembled tank. FR Comptoir en Gres Shilin épaisseur 1,2 cm avec bac assemblé. ES Encimera en Gres Shilin espesor 1,2 cm con decantador ensamblado.

EN Concealed power outlet module matt black. FR Module Prises de courant cachés noir mat. ES Módulo Tomas de corriente ocultas negro mate.

Sfumature neutre e delicate che fanno di terra e di sabbia.

Loft 2.2 PET Sabbia
Colonne e pensili

^{EN} Columns and wall units.
^{FR} Colonnes et armoires murales.
^{ES} Columnas y armarios de pared.



Gea PET Sabbia

Basi

^{EN} Bases.
^{FR} Bases.
^{ES} Bases.

^{EN} Neutral and delicate shades that taste of earth and sand. ^{FR} Nuances neutres et délicates qui sentent la terre et la sable. ^{ES} Matices neutros y delicados que saben a tierra y arena.

Sistemi di apertura / Opening systems / Systèmes d'ouverture / Sistemas de apertura

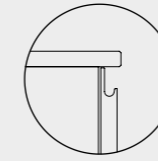

Basi
Profilo Z

^{EN} Bases with Z trim.
^{FR} Bases avec Profil Z.
^{ES} Bases con Perfil Z.

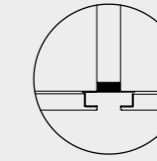

Colonne

Sistema gola piatta e profilo art. 485 laccato opaco NCS S 3005-Y50R

^{EN} Columns with flat rebate system and trim art. 485 matt lacquered NCS S 3005-Y50R. ^{FR} Colonnes avec Système à gorge plate et profil art. 485 laqué mat NCS S 3005-Y50R. ^{ES} Columnas con Sistema de ranura plana y perfil art. 485 lacado mate NCS S 3005-Y50R.

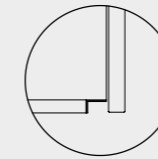

Pensili
Profilo gola pensile

^{EN} Wall units with wall-unit rebate trim. ^{FR} Armoires murales avec Profil à gorge armoire murale. ^{ES} Armarios de pared con Perfil ranura armario de pared.

Disegno tecnico / Technical drawing / Dessin technique / Dibujo técnico

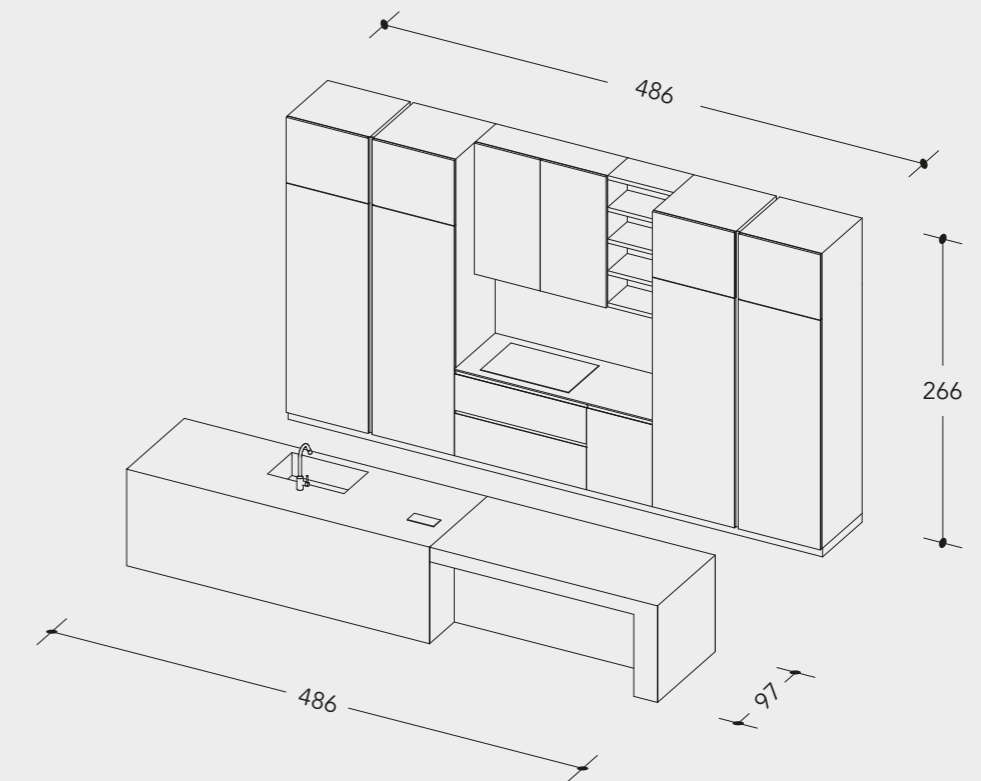

02
Il fascino
di una
scenografia
domestica.

EN The charm of a home setting.
FR Le charme d'une scénografie domestique.
ES El encanto de un escenario doméstico.

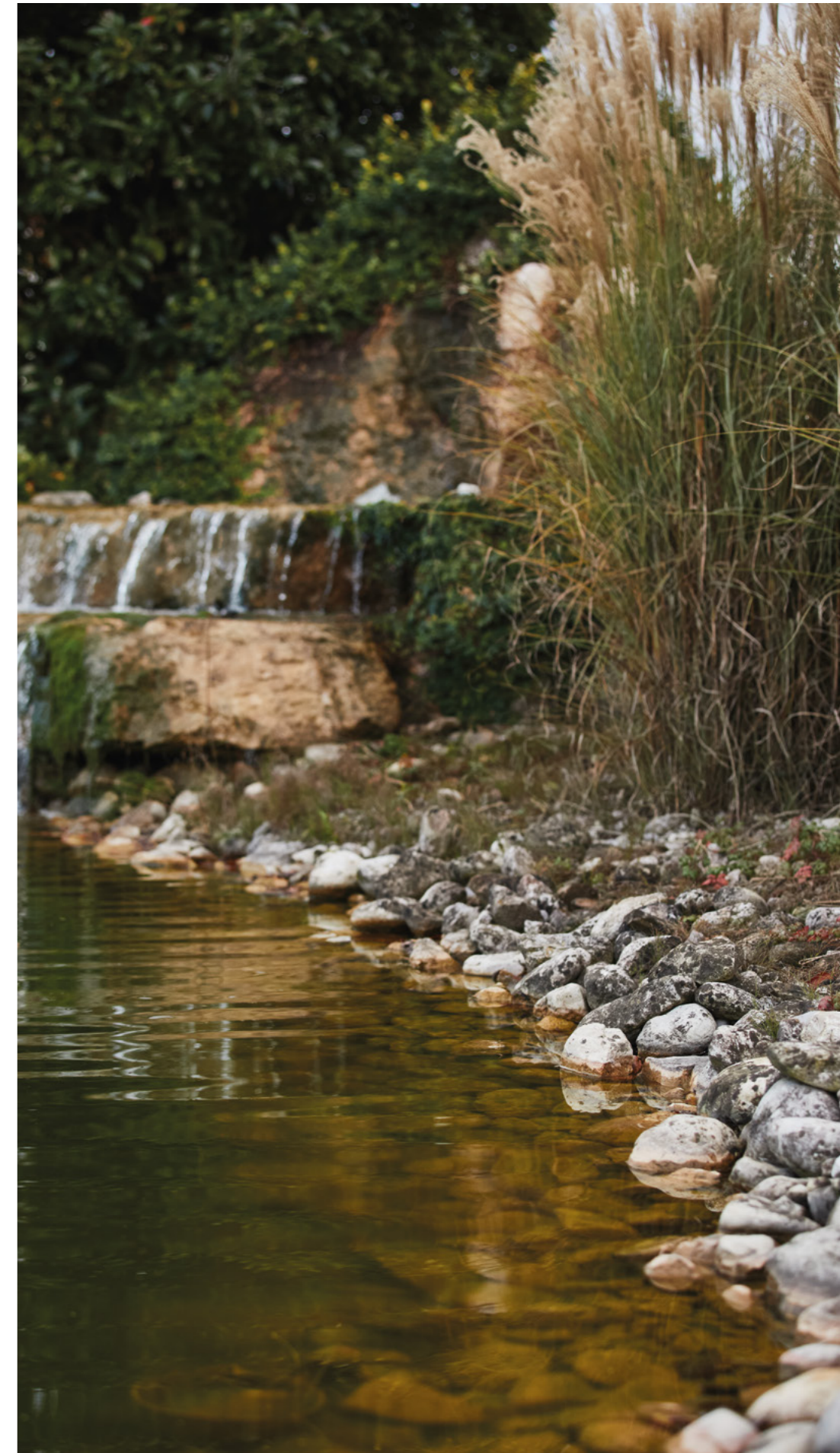



La cucina diventa un elemento scenico, pensato per raccordare gli spazi in modo fluido e libero, con un pizzico di teatralità.



Apertura Colonne
Profilo Z + H

EN Columns opening with Z + H trim. FR Ouverture Colonnes avec Profil Z + H. ES Apertura Columnas con Perfil Z + H.



EN Kitchen becomes a scenic element, designed to join spaces in a fluid and free way with a touch of theatricality. FR La cuisine devient un élément scénique, conçu pour raccorder les espaces de façon fluide et libre, avec une touche de théâtralité. ES La cocina deviene un elemento escénico, pensado para conectar los espacios de forma fluida y libre, con un toque de teatralidad.



Colonna a giorno living
 da 30 h. 258 cm
 Fenix Giallo Evora con
 piedini h. 8 cm

*EN Living open column 30 258 cm.
 h. Fenix Giallo Evora with feet 8
 cm. h. ^{ES} Colonne ouverte salon
 de 30 258 cm h. Fenix Giallo
 Evora avec petits pieds 8 cm h.
^{ES} Columna abierta sala de estar
 de 30 h. 258 cm Fenix Giallo
 Evora con pies h. 8 cm.*

Grazie al portale
passante,
cucinare diventa
un momento
di socialità e di
condivisione
familiare.



^{EN} Thanks to the pass-through portal, cooking becomes a moment of sociality and family sharing. ^{FR} Grâce au portail de passage, la cuisine devient un moment de socialité et de partage familial. ^{ES} Gracias al portal de paso, cocinar deviene un momento de sociabilidad y de compartir familiar.

AL32 Telaio antracite
Vetro opaco nero cannettato
Pensili h. 60

Basi e Colonne
Zoccolo h.8 cm metallo antracite

^{EN} AL32 anthracite Frame, matt black ribbed Glass, Wall-units 60 h. ^{FR} AL32 Châssis antracite, Verre mat noir côtelé, Armoires murales 60 h. ^{ES} AL32 Bastidor antracita, Vidrio mate negro acanalado, Armarios de pared h. 60.

^{EN} Bases and Columns with kick plate 8 cm. h. metal anthracite. ^{FR} Bases et Colonnes avec Plinthe 8 cm h. métal antracite. ^{ES} Bases y Columnas con Zócalo h. 8 cm metal antracita.

Oro e pietra vulcanica, colori ispirati all'energia della natura.

AL32 Telaio antracite
Vetro opaco nero cannettato
Pensili h. 60

^{EN} Wall-units 60 h. ^{FR} Armoires murales 60 h. ^{ES} Armarios de pared h. 60.



Loft 2.2
Fenix Giallo Evora
Elementi a giorno

^{EN} Open elements.
^{FR} Éléments ouverts.
^{ES} Elementos abiertos.



Gea
PET Vulcano
Basi, Colonne

^{EN} Bases, Columns.
^{FR} Bases, Colonnes.
^{ES} Bases, Columnas.

Loft 2.2
PET Vulcano
Pensili Sopracolonna

^{EN} Over-column wall units.
^{FR} Armoires murales sur colonne. ^{ES} Armarios de pared sobrecolumna.

^{EN} Gold and volcanic stone, colours inspired by the energy of nature.
^{FR} Or et pierre volcanique, couleurs inspirées de l'énergie de la nature.
^{ES} Oro y piedra volcánica, colores inspirados en la energía de la naturaleza.

Sistemi di apertura / Opening systems / Systèmes d'ouverture / Sistemas de apertura

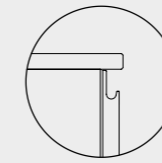

Basi
Profilo Z
^{EN} Bases with Z trim. ^{FR} Bases avec Profil Z. ^{ES} Bases con Perfil Z.

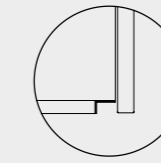

Pensili
Profilo gola pensile / Push pull
^{EN} Wall units with wall-unit rebate trim / Push-pull.
^{FR} Armoires murales avec Profil à gorge armoire murale / Push-pull.
^{ES} Armarios de pared con Perfil ranura armario de pared / Push-pull.

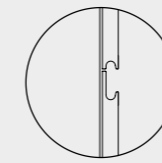

Colonne
Profilo Z + H
^{EN} Columns with Z + H trim. ^{FR} Colonnes avec Profil Z + H. ^{ES} Columnas con Perfil Z + H.

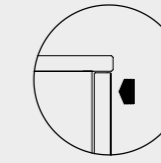

Disegno tecnico / Technical drawing / Dessin technique / Dibujo técnico

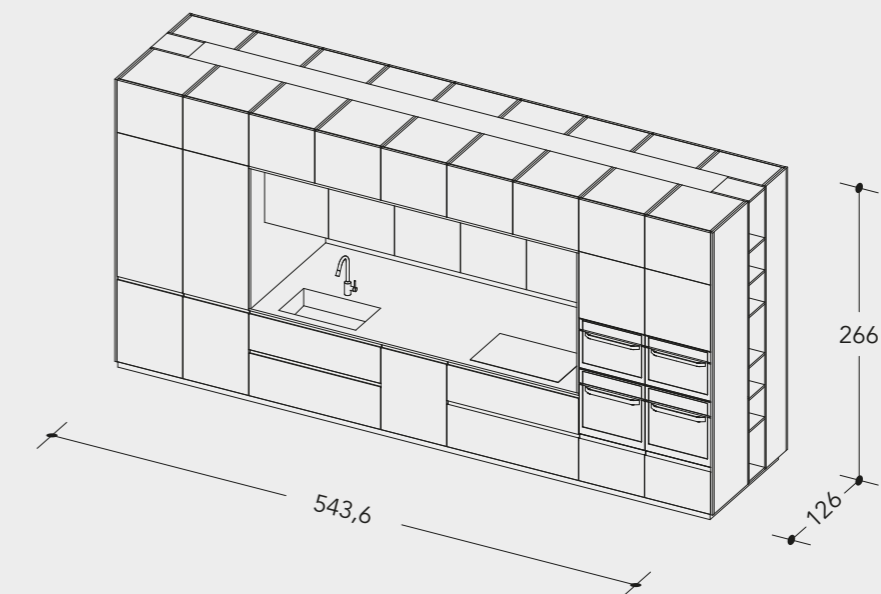

03
Il piacere della
semplicità
come filosofia
di vita.

*EN The pleasure of simplicity
as a philosophy of life.
FR Le plaisir de la simplicité
comme philosophie de vie.
ES El placer de la sencillez
como filosofía de vida.*





Superfici neutre e continue nascondono profondità inaspettate con elettrodomestici e accessori integrati.

^{EN} Neutral and continuous surfaces hide unexpected depths with integrated electrical appliances and accessories. ^{FR} Surfaces neutres et continues cachent des profondeurs inattendues grâce aux électroménagers et aux accessoires intégrés. ^{ES} Superficies neutras y continuas ocultan profundidades inesperadas con electrodomésticos y accesorios integrados.



Colonne
Fondo rialzato con zoccolo h.8 cm metallo bianco

Elemento a giorno Portabottiglie
Laccato opaco NCS S 3502-G con piedini art. 116

^{EN} Columns with raised bottom and kick plate 8 cm. h. metal white. ^{FR} Colonnes avec Fond rehaussé et plinthe 8 cm h. métal blanc. ^{ES} Columnas con Fondo elevado y zócalo h. 8 cm metal blanco.

^{EN} Open element with Bottle-stand matt lacquered NCS S 3502-G and feet art. 116. ^{FR} Élément ouvert avec Porte-bouteilles Laqué mat NCS S 3502-G et petits pieds art. 116. ^{ES} Elemento abierto con Botellero Lacado mate NCS S 3502-G y pies art. 116.



Colonne interne
Fondo rialzato con zoccolo h.8 cm metallo laccato opaco NCS S 3502-G

Accessori
Cassetti e cestoni Blum Legrabox bianco

^{EN} Internal columns with raised bottom and kick plate 8 cm. h. metal matt lacquered NCS S 3502-G. ^{FR} Colonnes intérieures avec Fond rehaussé et plinthe 8 cm h. métal laqué mat NCS S 3502-G. ^{ES} Columnas interiores con Fondo elevado y zócalo h. 8 cm metal lacado mate NCS S 3502-G.

^{EN} Accessories Drawers and deep drawers Blum Legabrox white. ^{FR} Accessoires Tiroirs et grands tiroirs Blum Legrabox blanc. ^{ES} Accesorios Cajones y cajones grandes Blum Legrabox blanco.

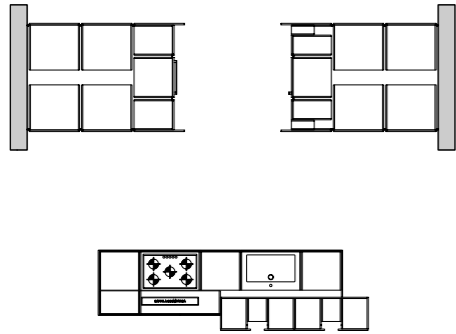

Piano lavoro
Gres Abu Dhabi White Silk sp. 1,2 cm

^{EN} Countertop in Gres Abu Dhabi White Silk 1,2 cm. th.
^{FR} Comptoir en Gres Abu Dhabi White Silk épaisseur 1,2 cm.
^{ES} Encimera en Gres Abu Dhabi White Silk espesor 1,2 cm.

La forza espressiva è nella consistenza dei materiali, nel gioco di volumi, nelle ombre delle ante a gola.

EN The expressive power is in the consistency of materials, in the interplay of volumes, in the shadows of the doors with rebate trim. *FR* La force expressive est dans la consistance des matériaux, dans le jeu des volumes, dans les ombres des portes avec profil à gorge. *ES* La fuerza expresiva está en la consistencia de los materiales, en el juego de volúmenes, en las sombras de las puertas con perfil de ranura.



Modulo Base XXL
Cassetto h.18 cm
più anta h.60 cm con
Apertura profilo Z + H

Basi
Zoccolo h.8 cm
metallo bianco

EN Base module XXL with drawer 18 cm. h. and door 60 cm. h. with opening Z + H profile. *FR* Module Base XXL avec tiroir 18 cm h. et porte 60 cm h. avec Ouverture profil Z + H. *ES* Módulo Base XXL con Cajón h. 18 cm y puerta h. 60 cm con Apertura perfil Z + H.

EN Bases with kick plate 8 cm. h. metal white. *FR* Bases avec Plinthe 8 cm h. métal blanc. *ES* Bases con Zócalo h. 8 cm metal blanco.

Sfumature fresche
e senza peso
che raccontano
la leggerezza
dell'aria.

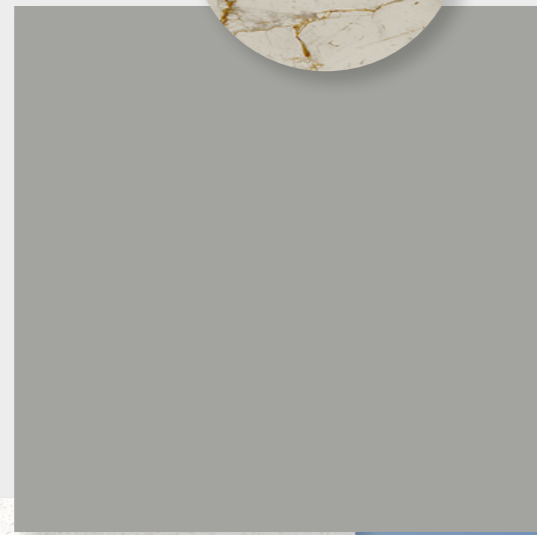

Loft 2.2 Line laccato opaco NCS S 3502-G
Colonne interne, Vani a giorno
isola h.96 cm

^{EN} Internal columns, Island open compartments 96 cm. h. ^{FR} Colonne intérieures, Compartiments d'îlot ouverts 96 cm h. ^{ES} Columnas interiores, Compartimientos de isla abiertos h. 96 cm.

Gea PET Calce
Basi

^{EN} Bases.
^{FR} Bases.
^{ES} Bases.

Loft 2.2 PET Calce
Colonne lato esterno,
Basi h.96

^{EN} External side columns, Bases 96 h. ^{FR} Colonne côté extérieur, Bases 96 h. ^{ES} Columnas lado exterior, Bases h. 96

^{EN} Fresh and weightless shades that tell the lightness of the air.
^{FR} Nuances fraîches et sans poids qui racontent la légèreté de l'air.
^{ES} Matices frescos y sin peso que hablan de la ligereza del aire.

Sistemi di apertura / Opening systems / Systèmes d'ouverture / Sistemas de apertura

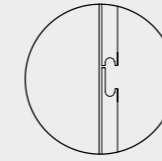

Basi
Profilo Z + H

^{EN} Bases with Z + H trim.
^{FR} Bases avec Profil Z + H.
^{ES} Bases con Perfil Z + H.

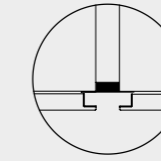

Colonne lato interno
Sistema gola piatta e profilo art. 485 laccato opaco NCS S 3502-G

^{EN} Internal side columns with flat rebate system and trim art. 485 matt lacquered NCS S 3502-G.
^{FR} Colonne côté intérieur avec Système à gorge plate et profil art. 485 laqué mat NCS S 3502-G.
^{ES} Columnas lado interior con Sistema de ranura plana y perfil art. 485 lacado mate NCS S 3502-G.

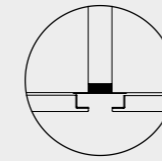

Colonne lato esterno
Sistema gola piatta e profilo art. 485 Bianco

^{EN} External side columns with flat rebate system and trim art. 485 White. ^{FR} Colonne côté extérieur avec Système à gorge plate et profil art. 485 Blanc. ^{ES} Columnas lado exterior con Sistema de ranura plana y perfil art. 485 Blanco.

Colonne h.96
Senza maniglia con anta sporgente

^{EN} Columns 96 h. without handle with projecting door. ^{FR} Colonne 96 h. sans poignée avec porte saillante. ^{ES} Columnas h. 96 sin manilla con puerta saliente.

Disegno tecnico / Technical drawing / Dessin technique / Dibujo técnico

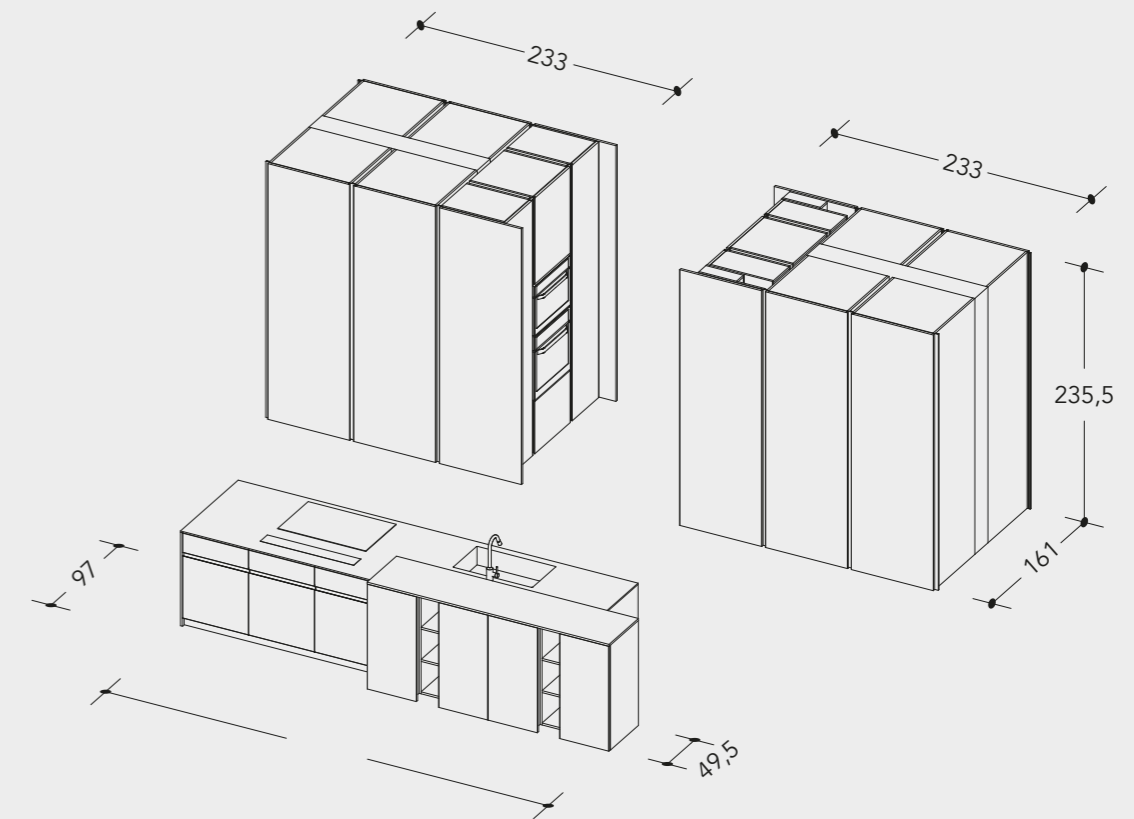

04
Atmosfera
classica, anima
contemporanea.

*EN Classic atmosphere,
contemporary soul.
FR Ambiance classique,
âme contemporaine.
ES Ambiente clásico,
alma contemporánea.*







Basi
Zoccolo h.8 cm
metallo champagne

Boiserie
con pannelli impiallacciati
Noce Canaletto - profili
e accessori finitura
champagne

Elementi a giorno

Portabottiglie

Laccati opaco
NCS S 2020-Y20R
con piedini h. 8 cm

EN Bases with kick plate 8 cm. h. metal champagne. *FR* Bases avec Plinthe 8 cm h. métal champagne. *ES* Bases con Zócalo h. 8 cm metal champaña.

EN Boiserie with veneered Noce Canaletto panels - trims and accessories champagne finish. *FR* Boiserie avec panneaux plaqués Noce Canaletto - profils et accessoires finition champagne. *ES* Boiserie con paneles enchapados Noce Canaellto - perfiles y accesorios acabado champaña.

EN Open elements with Bottle-stand matt lacquered NCS S 2020-Y20R and feet 8 cm. h. *FR* Éléments ouverts avec Porte-bouteilles Laqués mat NCS S 2020-Y20R et petits pieds 8 cm h. *ES* Elementos abiertos con Botellero Lacados mate NCS S 2020-Y20R y pies h. 8 cm.

Colonne
Fondo rialzato con
zoccolo h.8 cm
metallo champagne

Ante rientranti
con maniglia art. 725
laccata champagne

Elementi a giorno

Terminali

Laccati opaco
NCS S 2020-Y20R con
piedini Art. 116

EN Columns with raised bottom and kick plate 8 cm. h. metal champagne. *FR* Colonnes avec Fond rehaussé et plinthe 8 cm h. métal champagne. *ES* Columnas con Fondo elevado y zócalo h. 8 cm metal champaña.

EN Re-entrant doors with handle art. 725 lacquered champagne. *FR* Portes rentrantes avec poignée art. 725 laquée champagne. *ES* Puertas entrantes con manilla art. 725 lacada champaña.

EN Open elements with Terminali matt lacquered NCS S 2020-Y20R and feet art. 116. *FR* Éléments ouverts avec Terminali laqués mat NCS S 2020-Y20R et petits pieds art. 116. *ES* Elementos abiertos con Terminali lacados mate NCS S 2020-Y20R y pies art. 116.



Schienale luminoso
Magneto-Glass vetro opaco bianco con led integrato con accessori

Pensile
composto da 150 h.48 cm scolapiatti a sinistra con griglie antracite e vano da 60 a destra, anta unica apertura a ribalta.

Base
da 18 h.85,5 anta battente destra con piedini art. 116 - fusto laccato opaco NCS S 2020-Y20R apertura push pull

EN Bright back Magneto-Glass white matt glass with integrated LED and accessories. **FR** Dossier lumineux Magneto-Glass verre mat blanc avec LED intégré et accessoires. **ES** Respaldo luminoso Magneto-Glass vidrio mate blanco con luz led integrada y accesorios.

EN Assembled wall unit 150 48 cm. h. left plate rack with anthracite grates and right compartment 60, single door drop-leaf opening. **FR** Armoire murale assemblée de 150 48 cm h. égouttoir à vaisselle à gauche avec grilles anthracite et compartiment de 60 à droite, porte unique ouverture à abattant. **ES** Armario de pared ensamblado de 150 h. 48 cm escurreplatos a la izquierda con rejillas antracita y compartimiento de 60 a la derecha, puerta única apertura de vuelco.

EN Base 18 85,5 h. right overlapping door with feet art. 116 - shaft matt lacquered NCS S 2020-Y20R push-pull opening. **FR** Base de 18 85,5 h. porte battante droite avec petits pieds art. 116 - fût laqué mat NCS S 2020-Y20R ouverture push-pull. **ES** Base de 18 h. 85,5 puerta batiente derecha con pies art. 116 - fuste lacado mate NCS S 2020-Y20R apertura push-pull.

Classicità come senso dell'armonia, come proporzione tra gli elementi e sobrio equilibrio tra forma e funzione.

EN Classicism as a sense of harmony, as a proportion among elements and a sober balance between form and function. **FR** Caractère classique comme sens de l'harmonie, comme proportion entre les éléments et équilibre sobre entre forme et fonction. **ES** Clasicismo como sentido de la armonía, como proporción entre los elementos y sobrio equilibrio entre forma y función.



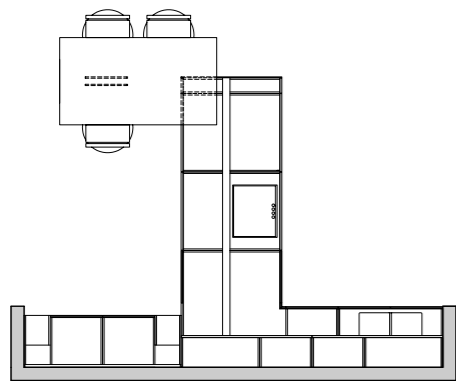
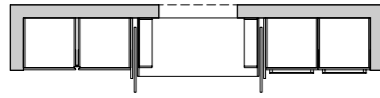

Piano lavoro
Gres Diamond Cream sp.1,2 cm

Piano Snack
Impiallacciato Noce Canaletto sp. 6 cm
con supporti in cristallo

^{EN} Countertop in Gres Diamond Cream 1,2 cm. th.
^{FR} Comptoir en Gres Diamond Cream épaisseur 1,2 cm.
^{ES} Encimera en Gres Diamond Cream espesor 1,2 cm

^{EN} Snack top in Veneered Noce Canaletto 6 cm. th.
with crystal supports. ^{FR} Plan Snack en Plaqué Noce
Canaletto épaisseur 6 cm avec supports en cristal.
^{ES} Top Snack en Enchapado Noce Canaletto espesor 6
cm con soportes en cristal.

Delicati contrappunti di cromie naturali.

**Loft 2.2 Wood
impiallacciato
Noce Canaletto**
Boiserie, Piano
snack

^{EN} Boiserie, Snack top.
^{FR} Boiserie, Plan snack.
^{ES} Boiserie, Top snack.



**Loft 2.2 Line laccato opaco
NCS S 2020-Y20R**
Ante rientranti, Vani a giorno,
Base da 18 h. 85,5 cm

^{EN} Re-entrant doors, Open compartments,
Base 18 85,5 cm. h. ^{FR} Portes rentrantes,
Compartiments ouverts, Base de 18 85,5
cm h. ^{ES} Puertas entrantes, Compartimientos
abiertos, Base de 18 h. 85,5 cm.

**Gea laccato opaco
NCS S 2020-Y20R**
Frontali h.18 cm, Elementi
a giorno Portabottiglie

^{EN} Front panels 18 cm. h., Open
elements for Bottle-stands.
^{FR} Pannaux frontals 18 cm h.,
Éléments ouverts Porte-bouteilles.
^{ES} Paneles frontales h. 18 cm,
Elementos abiertos para Botelleros

Gea PET Zucchero
Basi, Colonne forno

^{EN} Bases, Oven columns.
^{FR} Bases, Colonnes four.
^{ES} Bases, Columnas horno.

Loft 2.2 PET Zucchero
Pensili, Colonne, Pensili
sopracolonne

^{EN} Wall units, Columns, Over-column wall
units. ^{FR} Armoires murales, Colonnes,
Armoires murales sur colonne.
^{ES} Armarios de pared, Columnas,
Armarios de pared sobrecolumna.

^{EN} Delicate counterpoints
of natural shades of colour.
^{FR} Contrepoints délicats de
tonalités naturelles.
^{ES} Delicados contrapuntos
de tonos naturales.

Sistemi di apertura / Opening systems / Systèmes d'ouverture / Sistemas de apertura

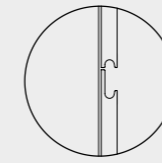

Basi e Colonne forno
Profilo Z + H

^{EN} Bases and Oven columns with
Z + H trim. ^{FR} Bases et Colonnes
four avec Profil Z + H. ^{ES} Bases y
Columnas horno con Perfil Z + H.

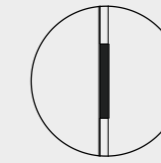

Ante rientranti
Maniglia art. 725 laccata
champagne

^{EN} Re-entrant doors with Handle
art. 725 lacquered champagne.
^{FR} Portes rentrantes avec Poignée
art. 725 laquée champagne.
^{ES} Puertas entrantes con Manilla
art. 725 lacada champaña.

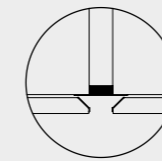

Colonne
Sistema gola piatta e profilo
art. 30° laccato champagne

^{EN} Columns with flat rebate
system and trim art. 30° lacquered
champagne. ^{FR} Colonnes avec
Système à gorge plate et profil art.
30° laqué champagne. ^{ES} Columnas
con Sistema de ranura plana y perfil
art. 30° lacado champaña.

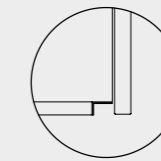

Pensili
Profilo gola pensile

^{EN} Wall units with wall-unit rebate
trim. ^{FR} Armoires murales avec
Profil à gorge armoire murale.
^{ES} Armarios de pared con Perfil
ranura armario de pared.

Disegno tecnico / Technical drawing / Dessin technique / Dibujo técnico

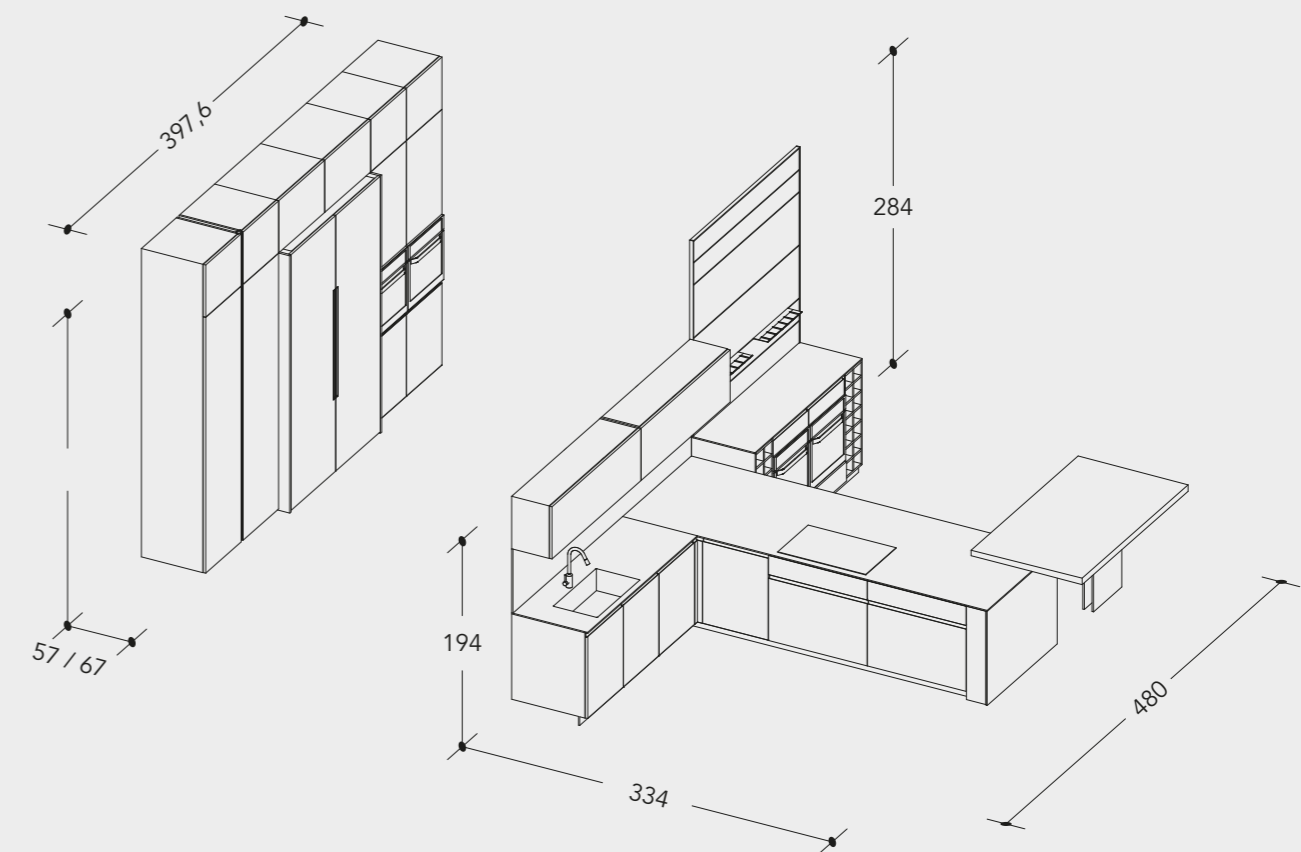

05
Eclettica e chic.
L'evoluzione
della convivialità.



EN Eclectic and chic. The evolution of conviviality.
FR Éclectique et chic. L'évolution de la convivialité.
ES Ecléctica y chic. La evolución de la convivencia.



**Accessori interni**

Colonna angolo dispensa 150
con vano lavatrice, divisioni in nobilitato Tessuto Perla
sp. 3,8 cm, piedino art. 116, luce a led Mini-Noor su
coperchio con sensore

^{EN} Internal accessories with Pantry corner column 150 with washing machine
compartment, partitions in veneered Tessuto Perla 3,8 cm. th., foot art. 116,
LED light Mini-Noor on top with sensor. ^{FR} Accessoires intérieurs avec Colonne
coin garde-manger de 150 avec compartiment machine à laver, partitions
en stratifié Tessuto Perla épaisseur 3,8 cm, petit pied art. 116, lumière LED
Mini-Noor sur top avec capteur. ^{ES} Accesorios interiores con Columna ángulo
alacena de 150 con compartimento lavadora, divisores en laminado Tessuto
Perla espesor 3,8 cm, pie art. 116, luz led Mini-Noor sobre top con sensor

Basi Penisola

Zoccolo h.8 cm metallo
antracite

Basi h.60 cm

Struttura di sostegno
per basi in tubolare di
alluminio h.26 cm finitura
antracite con piedini
regolabili

Colonne

Fondo rialzato con
zoccolo h.8 cm metallo
antracite

^{EN} Breakfast bar bases with kick
plate 8 cm. h. metal anthracite.
^{FR} Bases Plan de petit déjeuner
avec Plinthe 8 cm h. métal
anthracite. ^{ES} Bases Plan de
desayuno con Zócalo h. 8 cm
metal antracita.

^{EN} Bases 60 cm. h. Supporting
structure for bases in aluminium
tubes 26 cm. h. anthracite finish
with adjustable feet. ^{FR} Bases
60 cm h. Structure de soutien
pour bases en tubes d'aluminium
26 cm h. finition anthracite avec
petits pieds réglables. ^{ES} Bases h.
60 cm Estructura de soporte para
bases de tubos de aluminio
h. 26 cm acabado antracita con
pies regulables.

^{EN} Columns with raised bottom
and kick plate 8 cm. h. metal
anthracite. ^{FR} Colonnes avec
Fond rehaussé et plinthe 8 cm h.
métal anthracite. ^{ES} Columnas con
Fondo elevado y zócalo h. 8 cm
metal antracita.





Le colonne attrezzate nascondono vani funzionali. Elettrodomestici e accessori integrati moltiplicano le funzioni dei piani.

^{EN} The equipped columns hide functional compartments. Built-in electrical appliances and accessories multiply the functions of the tops. ^{FR} Les colonnes équipées cachent des compartiments fonctionnels. Les électroménagers et les accessoires intégrés multiplient les fonctions des plans. ^{ES} Las columnas equipadas ocultan compartimientos funcionales. Electrodomésticos y accesorios integrados multiplican las funciones de los planos.



Vasca costruita
da 74 x 44 cm
Gres Terrazo Ceppo Silk

Accessori
Canale attrezzato
Barazza acciaio inox
verniciato nero con
accessori

Modulo Prese
A scomparsa nero opaco

^{EN} Assembled tank 74 x 44 cm.
Gres Terrazo Ceppo Silk.
^{FR} Bac assemblé de 74 x 44 cm
Gres Terrazo Ceppo Silk.
^{ES} Decantador ensamblado de 74
x 44 cm Gres Terrazo Ceppo Silk.

^{EN} Accessories Equipped channel
Barazza black painted stainless
steel with accessories.
^{FR} Accessoires Canal équipé
Barazza acier inoxydable verni noir
avec accessoires. ^{ES} Accesorios
Canal equipado Barazza acero
inoxidable pintado negro con
accesorios.

^{EN} Concealed power outlet
module matt black. ^{FR} Module
Prises de courant cachés noir mat.
^{ES} Módulo Tomas de corriente
ocultas negro mate.

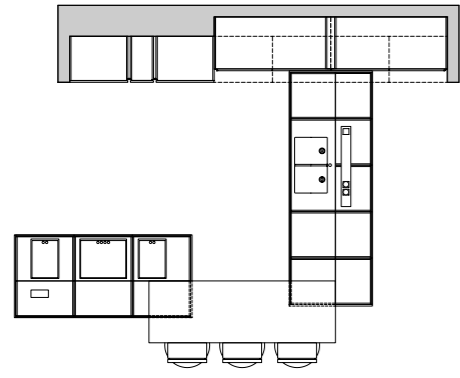

Piano lavoro
Gres Terrazo Ceppo Silk sp.2 cm

Piano Snack
Impiallacciato Eucalipto Affumicato sp. 8 cm

EN Countertop in Gres Terrazo Ceppo Silk 2 cm. th.
FR Comptoir en Gres Terrazo Ceppo Silk épaisseur 2 cm.
ES Encimera en Gres Terrazo Ceppo Silk espesor 2 cm.

EN Snack top in Veneered Smoked River Red Gum 8 cm. th.
FR Plan Snack en Plaqué Eucalyptus Fumé épaisseur 8 cm.
ES Top Snack en Enchapado Eucalitto Ahumado espesor 8 cm.

L'energia del fuoco. La forza della pietra e del metallo.

Loft 2.2 Line laccato opaco "ROSSO ANCORA" NCS S 6030-R
Colonne con elettrodomestici, Pensili sopra colonna

^{EN} Columns with electrical appliances, Over-column wall units. ^{FR} Colonnes avec électroménagers, Armoires murales sur colonne. ^{ES} Columnas con electrodomésticos, Armarios de pared sobrecolumna.

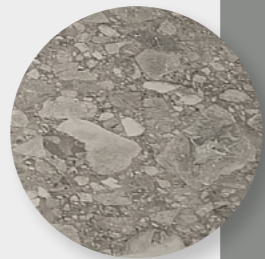

Loft 2.2 Wood impiallacciato Eucalipto Affumicato
Piano snack

^{EN} Snack top. ^{FR} Plan Snack. ^{ES} Top snack.

Gea PET Sasso
Basi, Colonne prof. 67 cm

^{EN} Bases, Columns 67 cm. deep. ^{FR} Bases, Colonnes profondeur 67 cm. ^{ES} Bases, Columnas profundidad 67 cm

^{EN} The energy of fire. The power of stone and metal. ^{FR} L'énergie du feu. La force de la pierre et du métal. ^{ES} La energía del fuego. La fuerza de la piedra y el metal.

Sistemi di apertura / Opening systems / Systèmes d'ouverture / Sistemas de apertura

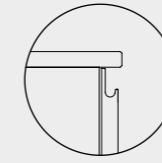

Basi
Profilo Z

^{EN} Bases with Z trim. ^{FR} Bases avec Profil Z. ^{ES} Bases con Perfil Z.

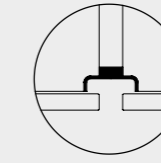

Colonne NCS S 6030-R
Sistema gola elle Antracite

^{EN} Columns NCS S 6030-R with rebate system el Anthracite. ^{FR} Colonnes NCS S 6030-R avec Système à gorge elle Anthracite. ^{ES} Columnas NCS S 6030-R con Sistema de ranura ele Antracita.

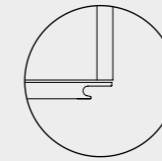

Colonne Sasso
Profilo Z verticale

^{EN} Columns Sasso with vertical Z trim. ^{FR} Colonnes Sasso avec Profil Z vertical. ^{ES} Columnas Sasso con Perfil Z vertical.

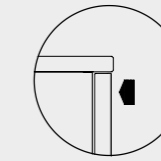

Pensili
Push pull

^{EN} Wall units with Push pull. ^{FR} Armoires murales avec Push-pull. ^{ES} Armarios de pared con Push-pull.

Disegno tecnico / Technical drawing / Dessin technique / Dibujo técnico

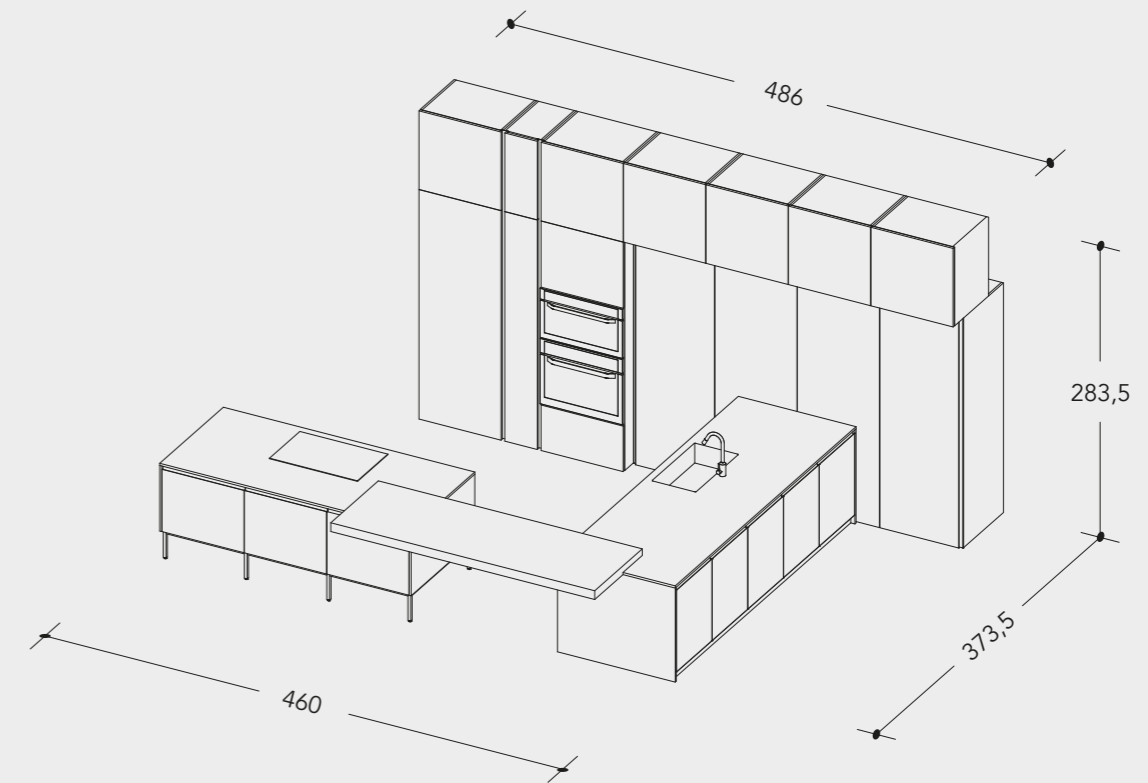

06
Essenziale
nella forma,
seducente
nei dettagli.

*EN Essential in form,
seductive in details.
FR Essentielle dans la forme,
séduisante dans les détails.
ES Esencial en la forma,
seductora en los detalles.*



Colonne attrezzate con ante a scomparsa, raffinate sovrapposizioni di materiali e giochi di spessori.

^{EN} Equipped columns with concealed doors, refined overlapping of materials and interplays of thicknesses.
^{FR} Colonnes équipées avec portes cachées, superpositions raffinées des matériaux et jeux d'épaisseurs.
^{ES} Columnas equipadas con puertas ocultas, refinadas superposiciones de materiales y juegos de espesores.



Basi
 Zoccolo h.8 cm metallo
 Bronzo

Colonne
 Fondo rialzato con
 zoccolo h.8 metallo
 bronzo

^{EN} Bases with kick plate 8 cm.
 h. metal Bronze. ^{FR} Bases avec
 Plinthe 8 cm h. métal Bronze.
^{ES} Bases con Zócalo h. 8 cm metal
 Bronce.

^{EN} Columns with raised bottom
 and kick plate 8 cm. h. metal
 bronze. ^{FR} Colonnes avec Fond
 rehaussé et plinthe 8 h. métal
 bronze. ^{ES} Columnas con Fondo
 elevado y zócalo h. 8 cm metal
 bronce.





Accessori interni
Colonna da 75 h.210 cm
con anta scorrevole
rientrante Tipo_D

Colonna estraibile da 45
h. 234 con meccanismo
Kesseböhmer Convoy
Lavido

^{EN} Internal accessories Column
75 210 cm. h. with re-entrant
sliding door Type_D. Pull-out
column 45 234 h. with mechanism
Kesseböhmer Convoy Lavido. ^{FR}
Accessoires intérieurs Colonne
de 75 210 cm h. avec porte
coulissante rentrante Type_D.
Colonne extractible de 45 234 h.
avec mécanisme Kesseböhmer
Convoy Lavido ^{ES} Accesorios
interiores Columna de 75 h. 210
cm con puerta corredera entrante
Tipo_D. Columna extraíble
de 45 h. 234 con mecanismo
Kesseböhmer Convoy Lavido.

Elementi a giorno living
Laccati opaco
NCS S 2005-B20G con
ripiani rientranti e luce a
led verticale Mini-Noor
con piedini art. 116

^{EN} Living open elements in matt
lacquered NCS S 2005-B20G with
re-entrant shelves and vertical
LED light Mini-Noor with feet art.
116. ^{FR} Éléments ouverts salon
en Laqué mat NCS S 2005-B20G
avec étagères rentrantes et
lumière LED verticale Mini-Noor
avec petits pieds art. 116.
^{ES} Elementos abiertos sala de estar
Lacados mate
NCS S 2005-B20G con estantes
entrantes y luz led vertical Mini-
Noor con pies art. 116



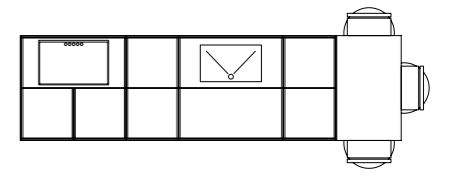
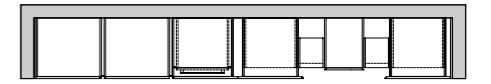

Piano lavoro

Gres Ossido Verderame sp.1,2 / 24 cm con vasca costruita

Piano Snack

Impiallacciato Loft 2.2. Wood Rovere Natura sp.4 cm

^{EN} Countertop in Gres Ossido Verderame 1,2 / 24 cm. th. with assembled tank. ^{FR} Comptoir en Gres Ossido Verderame épaisseur 1,2 / 24 cm avec bac assemblé. ^{ES} Encimera en Gres Ossido Verderame espesor 1,2 / 24 cm con decantador ensamblado.

^{EN} Snack top in Veneered Loft 2.2. Wood Rovere Natura 4 cm. th. ^{FR} Plan Snack en Plaqué Loft 2.2. Wood Rovere Natura épaisseur 4 cm. ^{ES} Top Snack en Enchapado Loft 2.2. Wood Rovere Natura espesor 4 cm.

Cromie vissute, elegantemente perfette.

**Loft 2.2 Line laccato opaco
NCS S 2005-B20G**
Elementi a giorno living

^{EN} Living open elements. ^{FR} Éléments ouverts salon. ^{ES} Elementos abiertos sala de estar.

**Loft 2.2 Wood impiallacciato
Rovere Naturale**
Piano snack

^{EN} Snack top. ^{FR} Plan snack. ^{ES} Top snack.



Loft 2.2 PET Creta
Colonne, Pensili sopra
colonna prof. 67 cm

^{EN} Columns, Over-column wall units 67 cm. deep. ^{FR} Colonnes, Armoires murales sur colonne profondeur 67 cm. ^{ES} Columnas, Armarios de pared sobrecolumna profundidad 67 cm.

Gea PET Creta
Basi

^{EN} Bases.
^{FR} Bases.
^{ES} Bases.

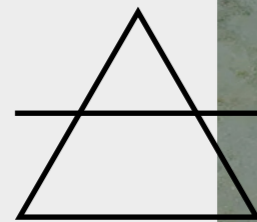

**AL32 Telaio Bronzo pann. Gres
Ossido Verderame**
Colonna, Sopracolonna prof. 57

^{EN} Column, Over column 57 deep. ^{FR} Colonne, Sur colonne profondeur 57. ^{ES} Columna, Sobrecolumna profundidad 57.



^{EN} Lived-in, elegantly perfect shades of colour. ^{FR} Tonalités vécues, élégamment parfaites. ^{ES} Tonos vivos, elegantemente perfectos.

Sistemi di apertura / Opening systems / Systèmes d'ouverture / Sistemas de apertura

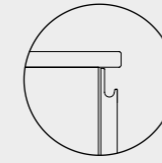

Basi
Profilo Z

^{EN} Bases with Z trim. ^{FR} Bases avec Profil Z. ^{ES} Bases con Perfil Z.

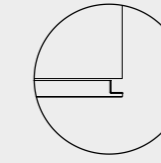

Colonna AL32 anta gres
Telaio Bronzo con Profilo
139 verticale

^{EN} Column AL32 stoneware door with bronze frame and vertical trim 139. ^{FR} Colonne AL32 porte grès avec Châssis Bronze et Profil 139 vertical. ^{ES} Columna AL32 puerta gres con Bastidor Bronze con Perfil 139 vertical.

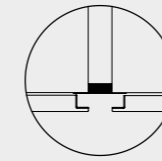

Colonne e Pensili
Sistema gola piatta e profilo
art. 485 laccato Bronzo

^{EN} Columns and Wall Units with flat rebate system and trim art. 485 lacquered Bronze. ^{FR} Colonnes et Armoires murales avec Système à gorge plate et profil art. 485 laqué Bronze. ^{ES} Columnas y Armarios de pared con Sistema de ranura plana y perfil 485 lacado Bronze.

Disegno tecnico / Technical drawing / Dessin technique / Dibujo técnico

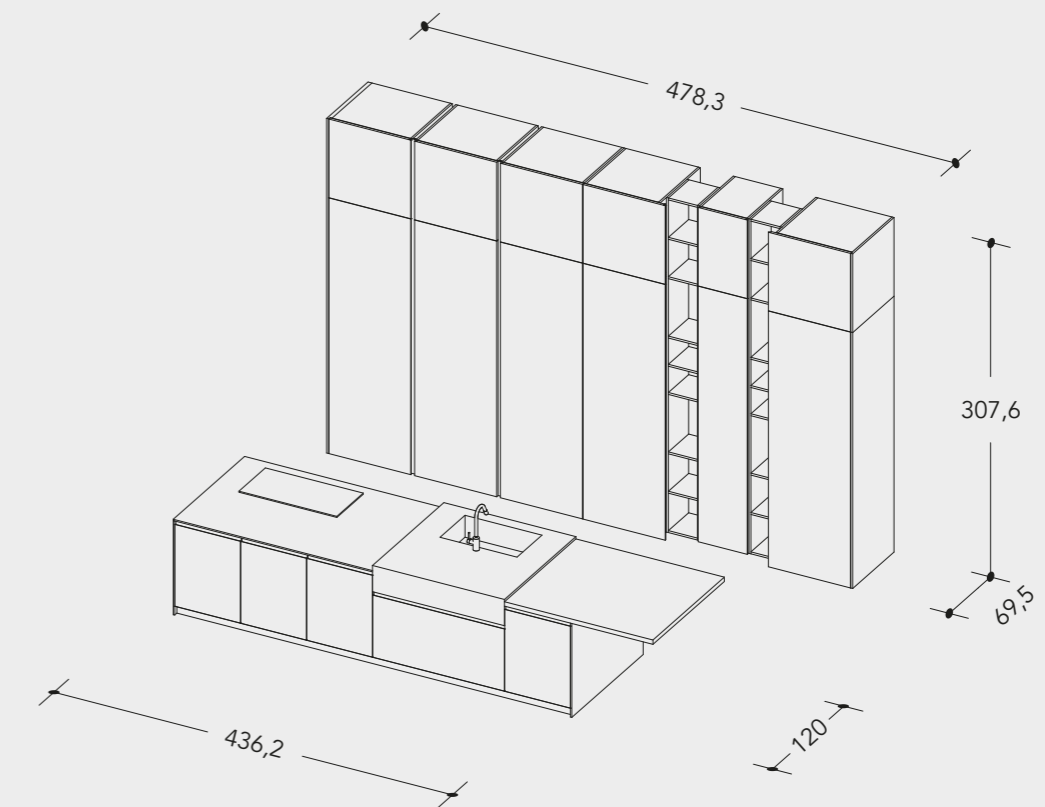

07
Sobrietà
naturale in
armonia con
l'ambiente.

EN Natural sobriety in harmony
with the environment.
FR Sobriété naturelle en
harmonie avec l'ambiance.
ES Sobriedad natural en
armonía con el ambiente.





Superfici che si incontrano creando geometrie composite. Materiali ispirati alla natura che esprimono un senso di leggerezza e di quiete.

^{EN} Surfaces that meet creating composite geometries. Materials inspired by nature that express a sense of lightness and quiet. ^{FR} Surfaces qui se rencontrent créant des géométries composites. Matériaux inspirés de la nature qui expriment une sensation de légèreté et de calme. ^{ES} Superficies que se encuentran creando geometrías compuestas. Materiales inspirados en la naturaleza que expresan una sensación de ligereza y tranquilidad.



Basi corpo avanzato
Zoccolo h.8 cm metallo
laccato NCS S 4005-G20Y

Basi e Colonne
Zoccolo h.8 cm metallo
bianco

^{EN} Bases jutted-out body with kick plate 8 cm. h. metal lacquered NCS S 4005-G20Y. ^{FR} Bases corps saillant avec Plinthe 8 cm h. métal laqué NCS S 4005-G20Y. ^{ES} Bases cuerpo saliente con Zócalo h. 8 cm metal lacado NCS S 4005-G20Y.

^{EN} Bases and Columns with kick plate 8 cm. h. metal white. ^{FR} Bases et Colonnes avec Plinthe 8 cm h. métal blanc. ^{ES} Bases y Columnas con Zócalo h. 8 cm metal blanco.





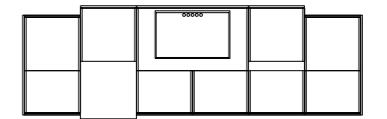
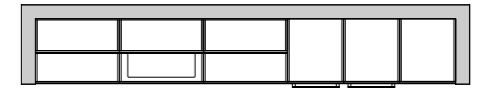

Piano lavoro e schienale
Gres Calacatta Roma Silk sp.1,2 / 23,5 cm

HPL stratificato Fenix Verde Kitami sp. 6 cm

^{EN} Countertop and back in Gres Calacatta Roma Silk 1,2 / 23,5 cm. th. ^{FR} Comptoir et dossier en Gres Calacatta Roma Silk épaisseur 1,2 / 23,5 cm. ^{ES} Encimera y respaldo en Gres Calacatta Roma Silk espesor 1,2 / 23,5 cm.

^{EN} Laminated HPL Fenix Verde Kitami 6 cm. th. ^{FR} HPL stratifié Fenix Verde Kitami épaisseur 6 cm. ^{ES} HPL laminado Fenix Verde Kitami espesor 6 cm.

Sfumature
chiare dal
fascino fresco
e familiare.

Gea PET Calce
Basi, Colonne

^{EN} Bases, Columns. ^{FR} Bases,
Colonnes. ^{ES} Bases, Columnas.

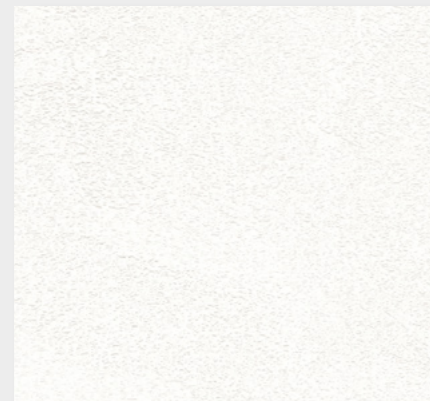

Loft 2.2 Fenix Verde Kitami
Basi corpo avanzato

^{EN} Bases juttred-out body.
^{FR} Bases corps saillant.
^{ES} Bases cuerpo saliente.



Loft 2.2 Wood impiallacciato
Rovere Puro cannettato
Pensili

^{EN} Wall units. ^{FR} Armoires murales.
^{ES} Armarios de pared.

^{EN} Light shades with a fresh and
familiar charm. ^{FR} Nuances claires au
charme frais et familier. ^{ES} Matices
claros con un encanto fresco y familiar.

Sistemi di apertura / Opening systems / Systèmes d'ouverture / Sistemas de apertura

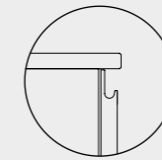

Basi h.60 cm
Profilo Z

^{EN} Bases 60 cm. h. with Z trim.
^{FR} Bases 60 cm h. avec Profil Z.
^{ES} Bases h. 60 cm con Perfil Z.

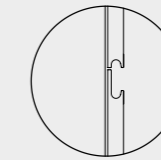

Colonne
Profilo Z + H

^{EN} Columns with Z + H trim.
^{FR} Colonnes avec Profil Z + H.
^{ES} Columnas con Perfil Z + H.

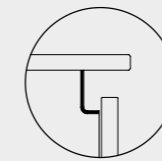

Basi corpo avanzato
Sistema gola elle laccato
NCS S 4005-G20Y

^{EN} Bases juttred-out body with rebate
system el lacquered NCS S 4005-G20Y.
^{FR} Bases corps saillant avec Système à
gorge elle laqué NCS S 4005-G20Y. ^{ES}
Bases cuerpo saliente con Sistema de
ranura ele lacado NCS S 4005-G20Y.

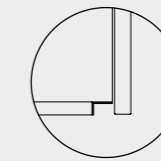

Pensili
Profilo gola pensile

^{EN} Wall units with wall-unit rebate
trim. ^{FR} Armoires murales avec
Profil à gorge armoire murale.
^{ES} Armarios de pared con Perfil
ranura armarío de pared.

Disegno tecnico / Technical drawing / Dessin technique / Dibujo técnico

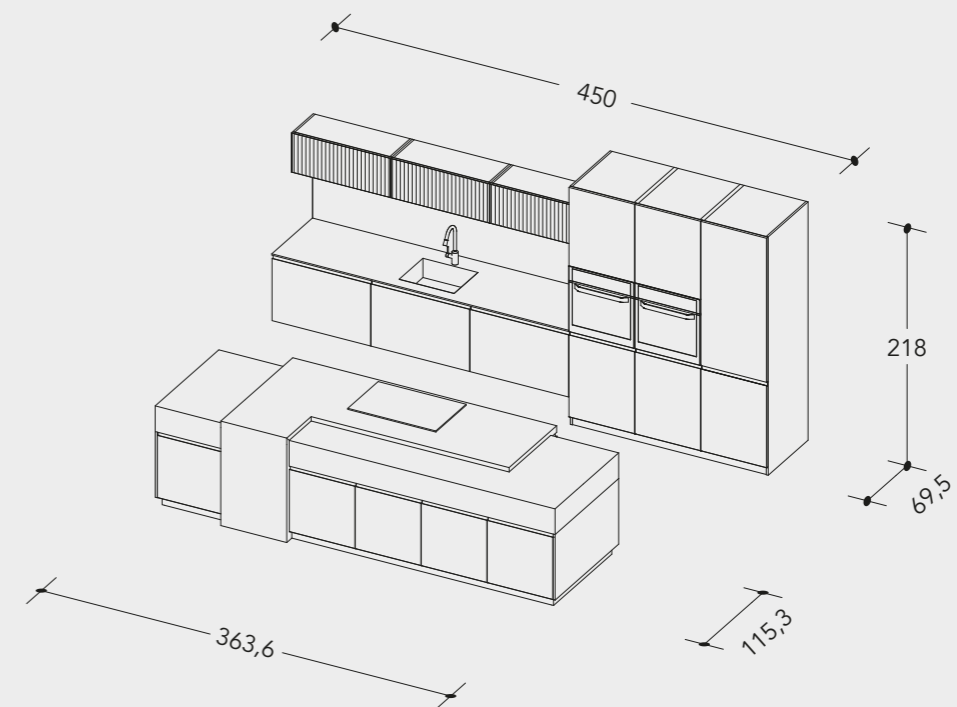

08
Il fascino
poetico della
"vie en rose".
Singolare,
femminile.

EN The poetic charm of the "vie en rose". Singular, womanly.
FR Le charme poétique de la « vie en rose ». Singulière, féminine.
ES El encanto poético de la "vie en rose". Singular, femenina.







Basi e Colonne
Zoccolo h.8 cm metallo
antracite

Elementi a giorno living
Finitura Pet Ardesia

^{EN} Bases and Columns with kick plate 8 cm. h. metal anthracite.
^{FR} Bases et Colonnes avec Plinthe 8 cm h. métal anthracite. ^{ES} Bases y Columnas con Zócalo h. 8 cm metal antracita.

^{EN} Living open elements in Finish Pet Ardesia. ^{FR} Eléments ouverts salon en Finition Pet Ardesia.
^{ES} Elementos abiertos sala de estar en Acabado Pet Ardesia

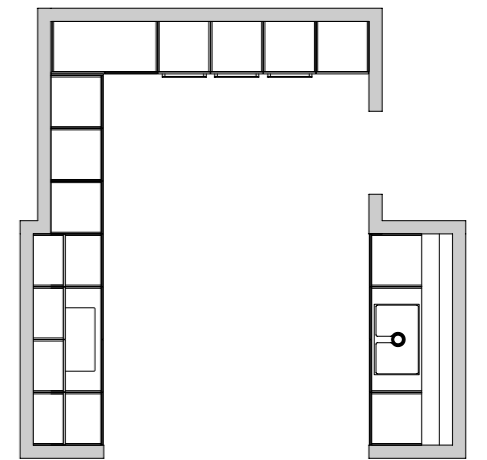

Schienale luminoso
Magneto-Glass vetro
lucido bianco con led
integrato e accessori

Piano lavoro
Marmo Fior di Pesco
sp. 3 cm

^{EN} Bright back Magneto-Glass white glossy glass with integrated LED light and accessories.
^{FR} Dossier lumineux Magneto-Glass verre poli blanc avec LED intégré et accessoires. ^{ES} Respaldo luminoso Magneto-Glass vidrio pulido blanco con luz led integrada y accesorios.

^{EN} Countertop in Marble Fior di Pesco 3 cm. th. ^{FR} Comptoir en Marbre Fior di Pesco épaisseur 3 cm. ^{ES} Encimera en Mármol Fior di Pesco espesor 3 cm.



L'atmosfera asseconda lo stile sofisticato e accogliente della casa. L'attenzione è sui dettagli e sui ricercati contrasti cromatici.

EN The atmosphere is in keeping with the sophisticated and welcoming style of the house. The focus is on details and refined chromatic contrasts. FR L'ambiance est en harmonie avec le style sophistiqué et accueillant de la maison. L'accent est mis sur les détails et les contrastes chromatiques raffinés. ES El ambiente está en consonancia con el estilo sofisticado y acogedor de la casa. La atención se centra en los detalles y los refinados contrastes cromáticos.



Colonna angolo
Con meccanismo
Kesseböhmer LeMans
Regular Soft antracite

*EN Corner column with mechanism
Kesseböhmer LeMans Regular
Soft anthracite. FR Colonne coin
avec mécanisme Kesseböhmer
LeMans Regular Soft anthracite.
ES Columna ángulo con
mecanismo Kesseböhmer LeMans
Regular Soft antracita*



Accessori

Mensole con supporti a scomparsa laccate lucido NCS S 1515-Y90R con luce a led Malindi incassata

EN Accessories Shelves with concealed supports glossy lacquered NCS S 1515-Y90R with built-in LED light Malindi.
FR Accessoires Étagères avec supports cachés laqués poli NCS S 1515-Y90R avec lumière LED Malindi intégrée.
ES Accesorios Mésulas con soportes ocultos lacadas pulido NCS S 1515-Y90R con luz led Malindi empotrada.



Romantici
toni cipria.
Superfici
lucide e
riflettenti.



**Loft 2.2 Line laccata
lucida NCS S 1515-Y90R**
Pensili

^{EN} Wall units. ^{FR} Armoires murales.
^{ES} Armarios de pared.

**Gea laccata lucida
NCS S 1515-Y90R**
Colonne

^{EN} Columns. ^{FR} Colonnes.
^{ES} Columnas.

Gea PET Ardesia
Basi, Vani a giorno

^{EN} Bases, Open compartments.
^{FR} Bases, Compartiments ouverts.
^{ES} Bases, Compartimientos abiertos.

^{EN} Romantic powder tones. Glossy
and reflective surfaces. ^{FR} Tons poudre
romantiques. Surfaces brillantes
et réfléchissantes. ^{ES} Románticos
tonos polvos de tocador. Superficies
brillantes y reflectantes.

Sistemi di apertura / Opening systems / Systèmes d'ouverture / Sistemas de apertura

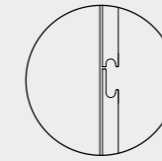

Basi e Colonne
Profilo Z + H

^{EN} Bases and Columns with Z + H
trim. ^{FR} Bases et Colonnes avec
Profil Z + H. ^{ES} Bases y Columns
con Perfil Z + H.

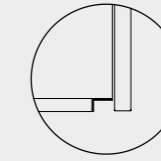

Pensili
Profilo gola pensile /
Push pull

^{EN} Wall units with wall-unit
rebate trim / Push-pull.
^{FR} Armoires murales avec
Profil à gorge armoire
murale / Push-pull.
^{ES} Armarios de pared con
Perfil ranura armario de
pared / Push-pull.

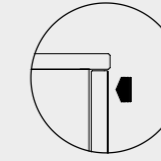

Disegno tecnico / Technical drawing / Dessin technique / Dibujo técnico

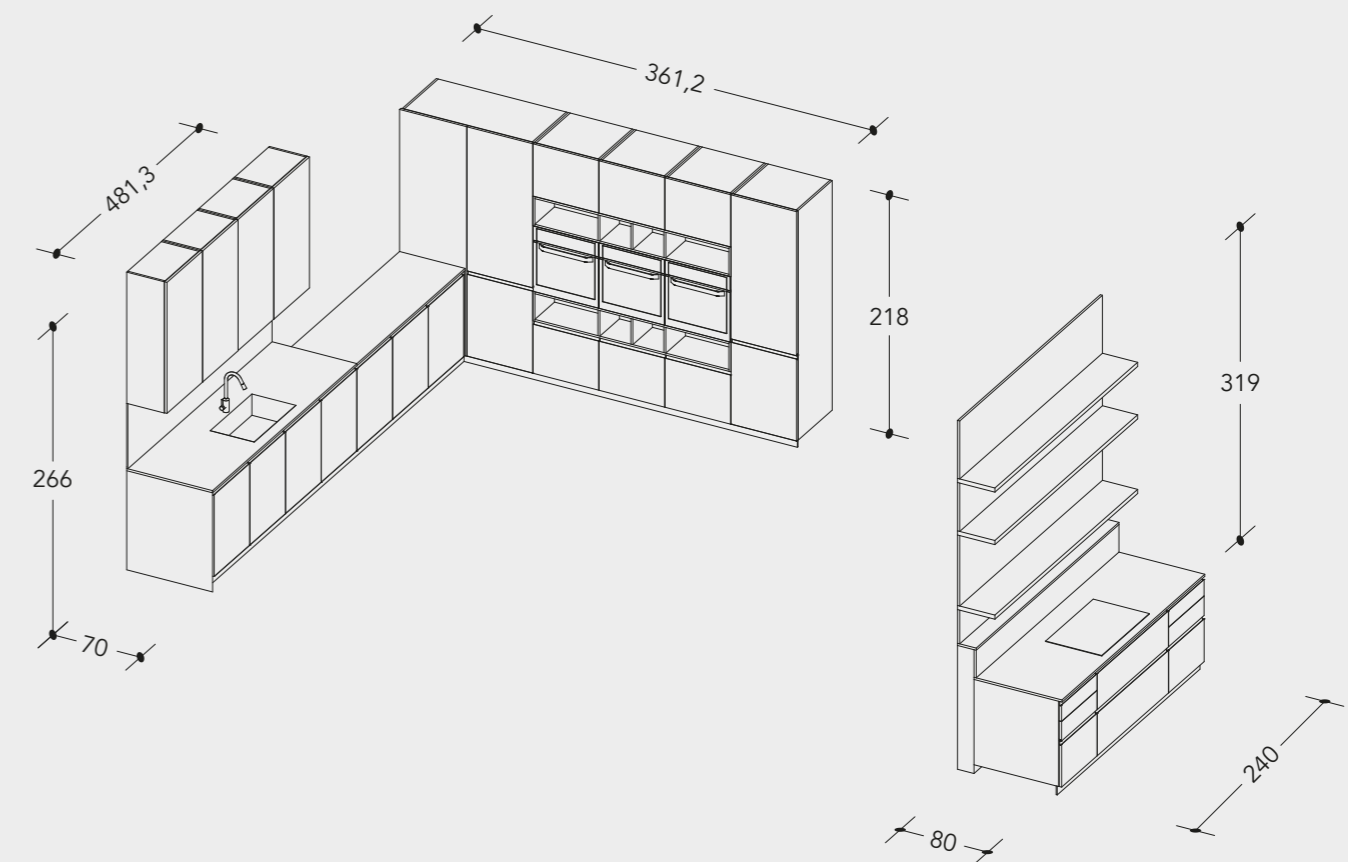

communication concept
& graphic design
Prora.Studio

digital images
Lumordesign.it

design
Style Division Arrex

color separation & print
Grafichegemma.it

^{IT} Le immagini stampate non riproducono perfettamente i colori e i toni dei nostri modelli. L'azienda si riserva di apportare tutte le modifiche ritenute necessarie al continuo miglioramento e rinnovamento dei modelli.

^{EN} The printed images do not perfectly reproduce the colours and tones of our models. The company reserves the right to make all changes deemed necessary for the continuous improvement and renewal of the models.

^{FR} Les images imprimées ne reproduisent pas parfaitement les couleurs et les tons de nos modèles. L'entreprise se réserve le droit d'apporter toutes les modifications jugées nécessaires pour l'amélioration continue et le renouvellement des modèles.

^{ES} Las imágenes imprimadas no reproducen perfectamente los colores y tonos de nuestros modelos. La empresa se reserva el derecho de realizar todas las modificaciones que considere necesarias para la mejora continua y la renovación de los modelos.

ARREX
L E _ C U C I N E

ARREX LE CUCINE
31040 Mansuè (TV) Italy
Via Portobuffolè, 32

T. +39 0422 741331
E. info.arrex@arrex.it
W. arrex.it

A part of Group

**ATMA**
INDUSTRIE DEL MOBILE

ARREX
L E _ C U C I N E

ARREX LE CUCINE
31040 Mansuè (TV) Italy
Via Portobuffolè, 32

T. +39 0422 741331
E. info.arrex@arrex.it
W. arrex.it